

DETECTORS

Catalytic Combustion Detector - CCD

Overview

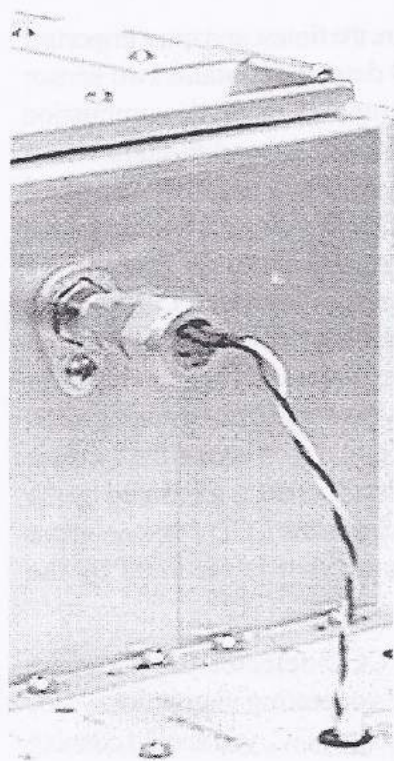

CCD on Column Oven

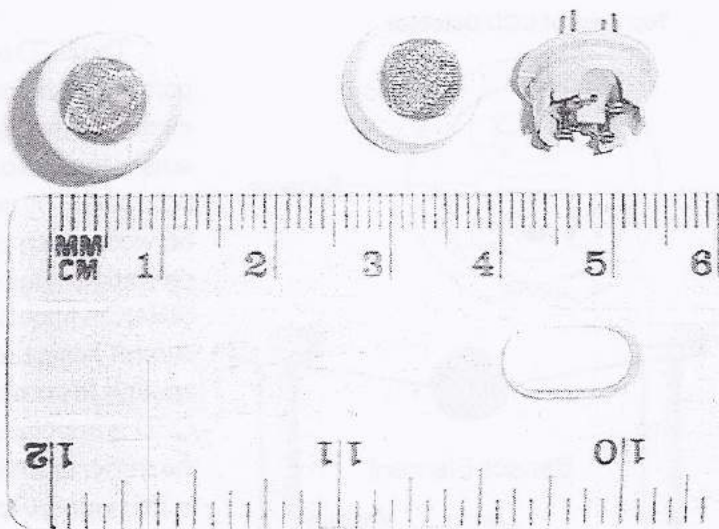

CCD Detector and protective cap (cap is removed prior to installation)

The Catalytic Combustion Detector responds to all hydrocarbons with the selectivity of an FID and the sensitivity of a TCD. The entire detector's diameter is merely one centimeter. Its sensor element consists of a tiny coil of platinum wire embedded in a catalytic ceramic bead. Each CCD detector has a pair of sensor elements. The sensors are housed in high-grade, flame-

proof nylon, and protectively capped with a fine steel mesh. In SRI GCs, the CCD detector is mounted on the wall of the Column Oven in a brass housing, as shown in the top left picture. The analytical column residing in the Column Oven is connected to the detector through the oven wall; the example shown at bottom left is an SRI Gas-less™ Educational GC featuring a CCD detector and a 1m (3') Hayesep-D packed column. The

CCD detector is especially suited for gas-less operation because it can operate on ambient air, requiring no high pressure cylinder gases such as hydrogen or helium. In the GC system pictured at left, a built-in air compressor supplies the carrier gas for the CCD.

The CCD detector can also be used as a hydrocarbon monitor in non-chromatographic applications where the CCD senses the total hydrocarbon content of a flowing air stream, or as a hydrogen/hydrocarbon leak detector.

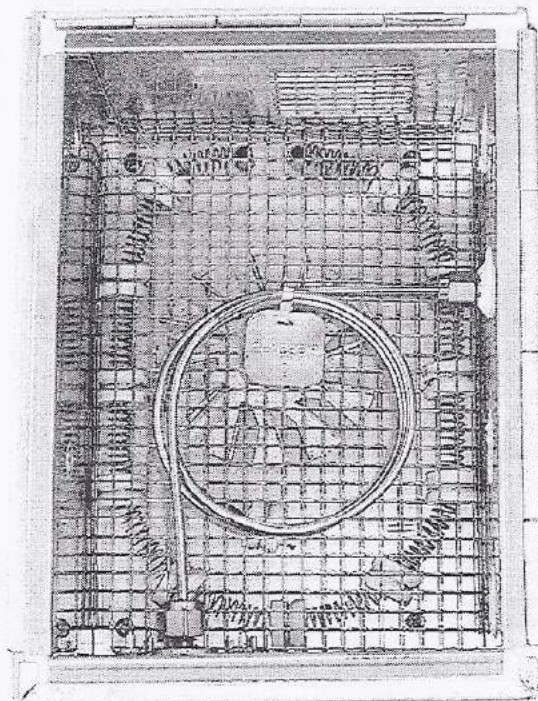

DETECTORS

Catalytic Combustion Detector - CCD

Theory of Operation

Top View of CCD Detector

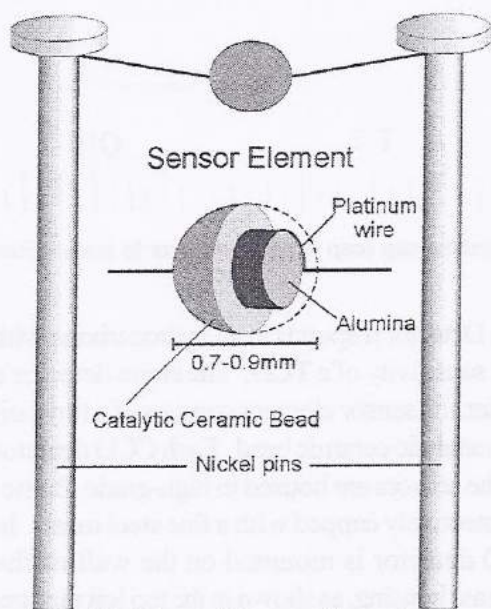
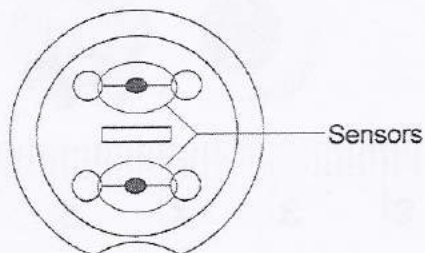

Side View of Sensor Element

The CCD sensor elements are the tiniest and most important part of the detector. Each CCD detector contains two sensor elements, but uses only one at a time. A catalytic combustion sensor consists of a coil of platinum wire around an alumina core surrounded by noble metal catalysts. Each sensor is suspended between a pair of nickel pins. The detector is shipped with a protective nylon cap topped with steel mesh, but is installed on a SRI GC without it. During a chromatographic run, a 150 milliamp current heats the catalytic ceramic bead to around 500°C, hot enough to combust hydrocarbon molecules on contact. The CCD is maintained in an oxidative environment by using air as the carrier or make-up gas. This combustion causes the increase in temperature and change in resistance that is measured by the sensor. This change in resistance causes the CCD detector output to change, which produces a peak that is recorded by the PeakSimple data system.

To prolong the life of your CCD detector, use it in strict accordance with your GC system's operating instructions. For instance, if you have an SRI Mud-Logger GC, you should connect your sample streams at 10psi so that no more than 5mL/min of pure hydrocarbon flow reaches the CCD. In the event of a sensor burn-out, simply remove the white and black wires from the top two nickel pins, and move them to

the bottom pair of nickel pins to connect them to the second sensor. It does not matter which wire goes on which pin. To replace the CCD detector, unscrew its brass fitting after removing the wires from the nickel pins. Pull out the old one and remove the protective cap from the replacement. Sensor-side first, insert the replacement into the fitting with its half-moon shaped cut-out on the bottom. Replace the fitting and **HAND TIGHTEN** it. If the detector fitting is screwed on too tightly, the detector will not receive proper gas flow. Next, slip the black and white wire plugs over the pins, and your replacement CCD detector is ready to use.

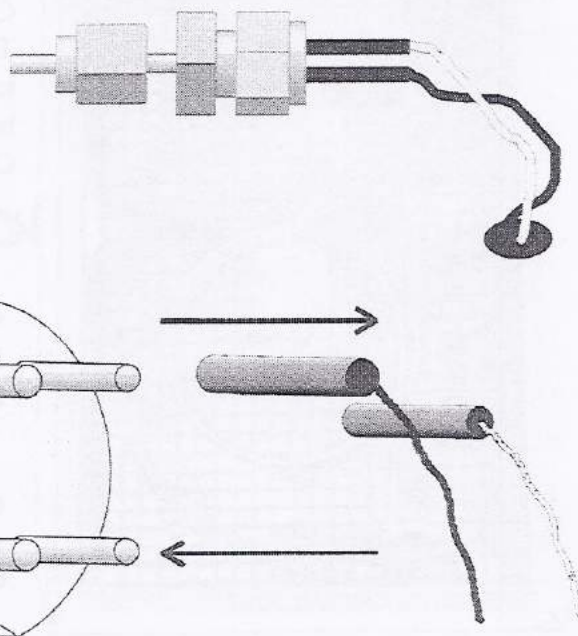

Expected Performance

CCD Detector Noise Run

Column = 1m Hayesep D
Flow = 37mL/min

Isothermal Temperature Program:
Initial Hold Ramp Final
80°C 15.00 0.00 80°C

Enlarged for clarity

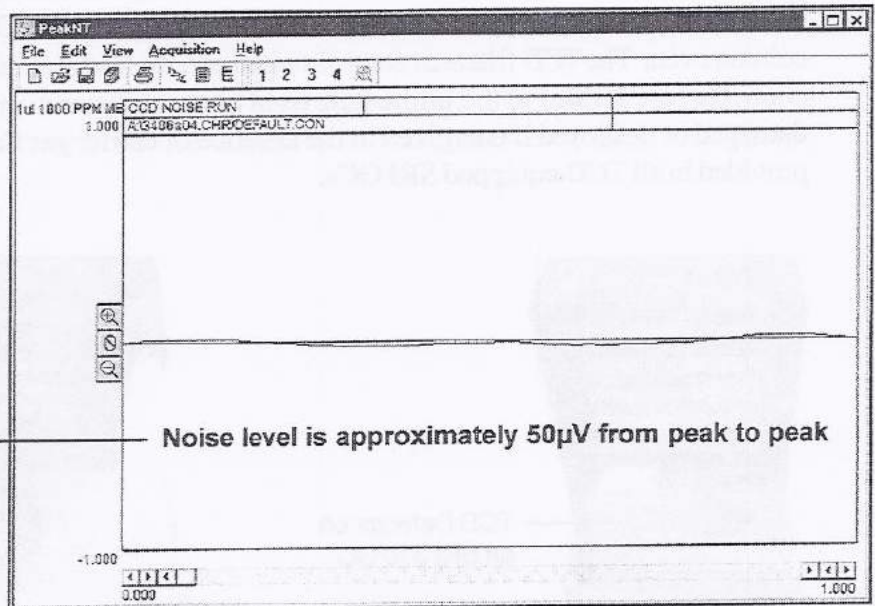
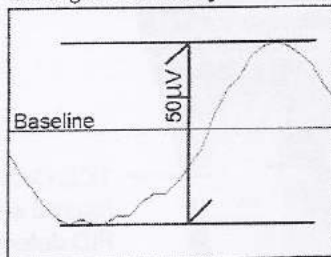

Factory Test Run of a Gas-less™ Educational GC System

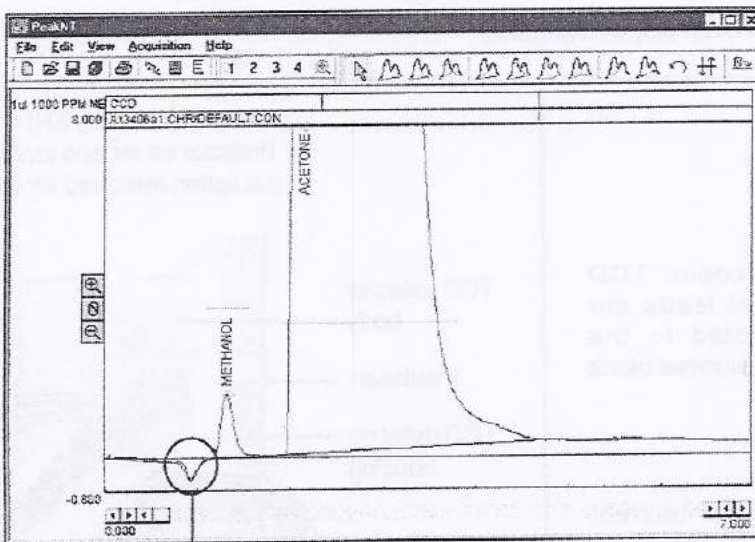

Column = 1m Hayesep D
Flow = 37mL/min
Sample = 1µL 1000ppm Methanol/Acetone mix; direct injection

Isothermal Temperature Program:
Initial Temp Hold Ramp Final Temp
130°C 10.00 0.00 130°C

RESULTS:

Component	Retention	Area
Methanol	0.816	13.2030
Acetone	2.000	6945.3570
Total		6958.5600

Negative water peak

Overview

The Thermal Conductivity Detector (TCD) is the most universal detector available. Depending on the compound, the TCD responds with a detection range of 0.01% to 100% (100-1,000,000ppm). The SRI TCD consists of four filaments housed in a stainless steel detector block. The TCD detector block is installed in its own thermostatically-controlled oven for stability. The TCD oven is mounted on the right rear of the column oven. The TCD filament control switch and the bridge terminal block to which the filament leads are connected are located to the immediate right of the detector oven. Since the four TCD filaments can be damaged or destroyed if energized in the absence of carrier gas flow, a TCD filament protection circuit is provided in all TCD-equipped SRI GCs.

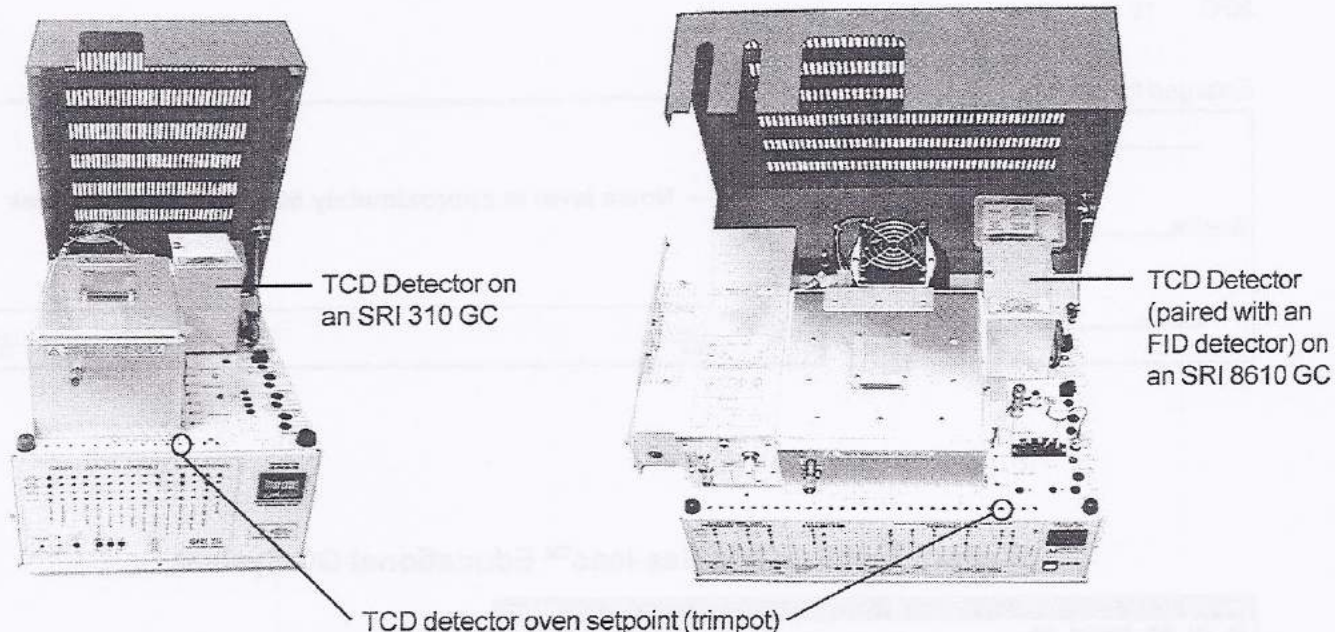

TCD Detector on an SRI GC

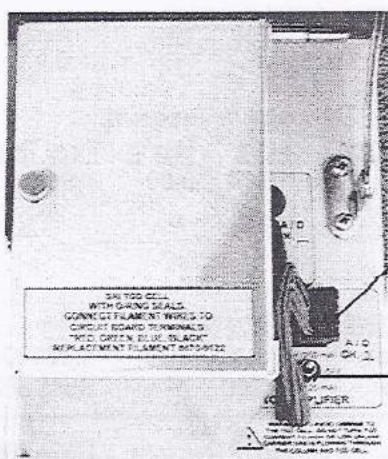

Color-coded TCD filament leads are connected to the bridge terminal block

TCD filament current control switch

TCD Detector on an SRI GC with detector cover and top/front insulation removed for clarity

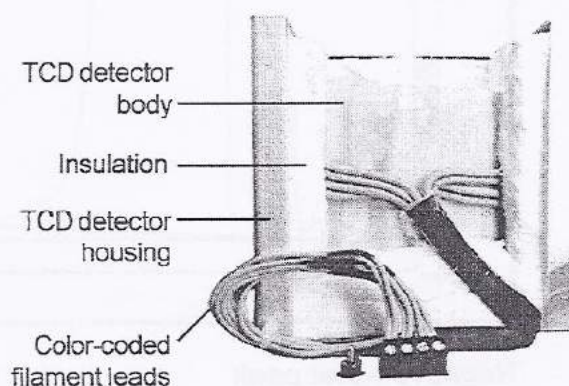

DETECTORS

Thermal Conductivity Detector - TCD

Theory of Operation

The TCD detector measures the difference in thermal conductivity in the carrier gas flow and the analyte peaks. Every compound possesses some degree of thermal conductivity, and may therefore be measured with a TCD detector. Due to its high thermal conductivity and safety, helium carrier is most often used with TCD detectors. However, other gases may be used such as nitrogen, argon, or hydrogen.

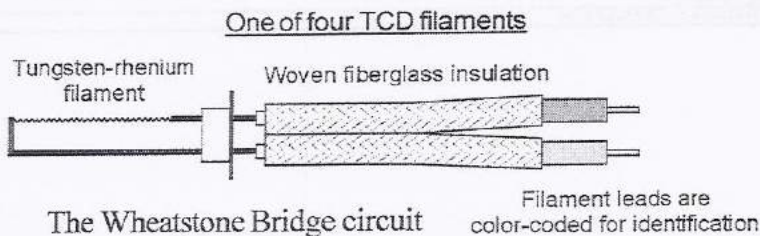

TCD filament bridge

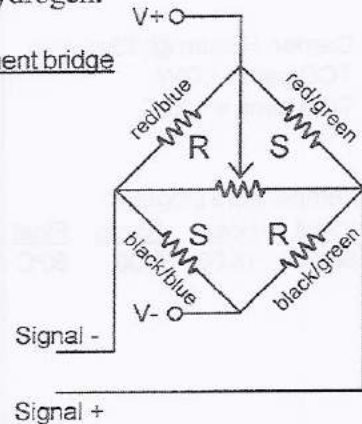

The Wheatstone Bridge circuit design in the SRI TCD uses four general-purpose tungsten-rhenium filaments for sample analysis. Two of the filaments are exposed to the sample-laden carrier gas flow and provide the actual chromatographic signal. The other two filaments are provided with clean carrier flow, enabling them to be used as a baseline reference signal. When the effluent from the column flows over the two sample stream filaments, the bridge current is unbalanced with respect to the reference signal. This deflection is translated into an analog signal which is sent to the data system for analysis.

The four pairs of filament leads are color-coded in two-color units; each color is used on two different leads. All eight wires are connected to the bridge current supply via four setscrew-type terminal connectors on the top control panel of the GC. Silkscreened labelling on the chassis indicates which color wire connects to each terminal.

The TCD detector block is divided into two cells containing two filaments each. One cell holds the reference pair while the other cell holds the sample pair. All four TCD filaments are physically identical except for their color-coding. The carrier gas is plumbed so that it exits the Electronic Pressure Controller module, flows through the polishing filter, through the reference side of the TCD bridge, then through the injection port to the column, and from the column to the sample side of the TCD bridge. After the flow passes through the sample cell, it is directed back out of the TCD oven and into the column oven through the TCD detector outlet, where it may be routed to a subsequent detector or to vent. All four TCD detector inlet/outlet tubes are 1/16" stainless steel.

Simplification of filament interconnection

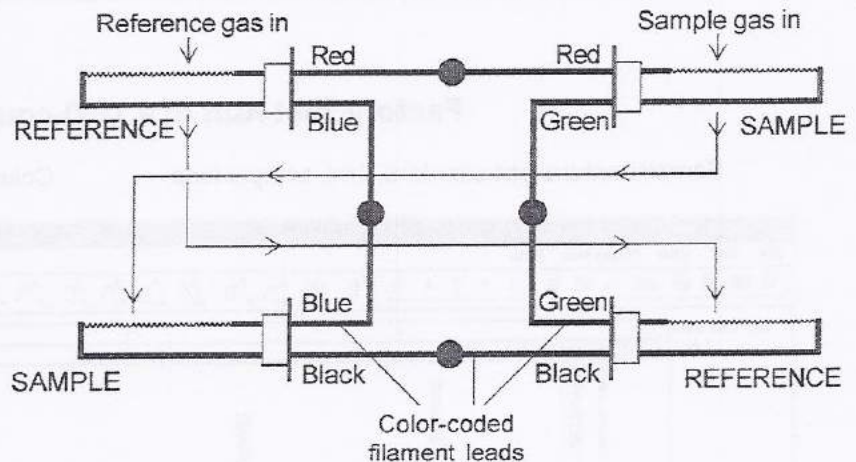

TCD carrier gas flow diagram

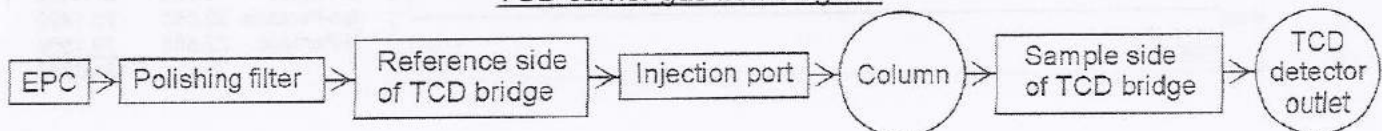

DETECTORS

Thermal Conductivity Detector - TCD

Expected Performance

TCD Noise Run

Carrier: Helium @ 10mL/min
 TCD gain = LOW
 TCD temp = 100°C

Temperature program:

Initial	Hold	Ramp	Final
80°C	15.00	0.00	80°C

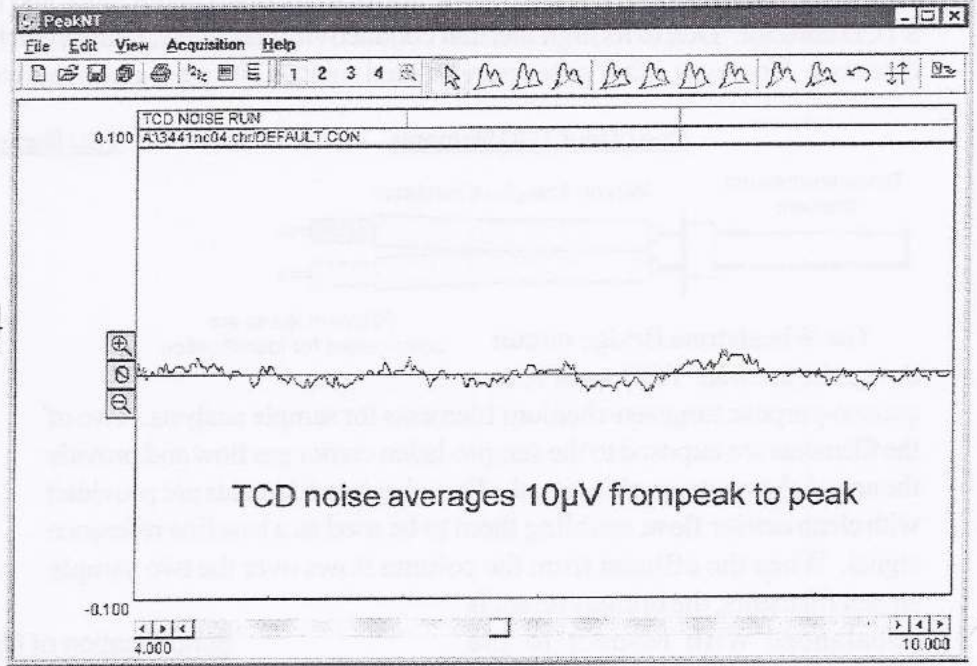

Factory Test Run of a TCD-equipped SRI GC

Sample: natural gas standard, 1mL sample loop

Columns: 1m Molecular Sieve, 2m Silica Gel

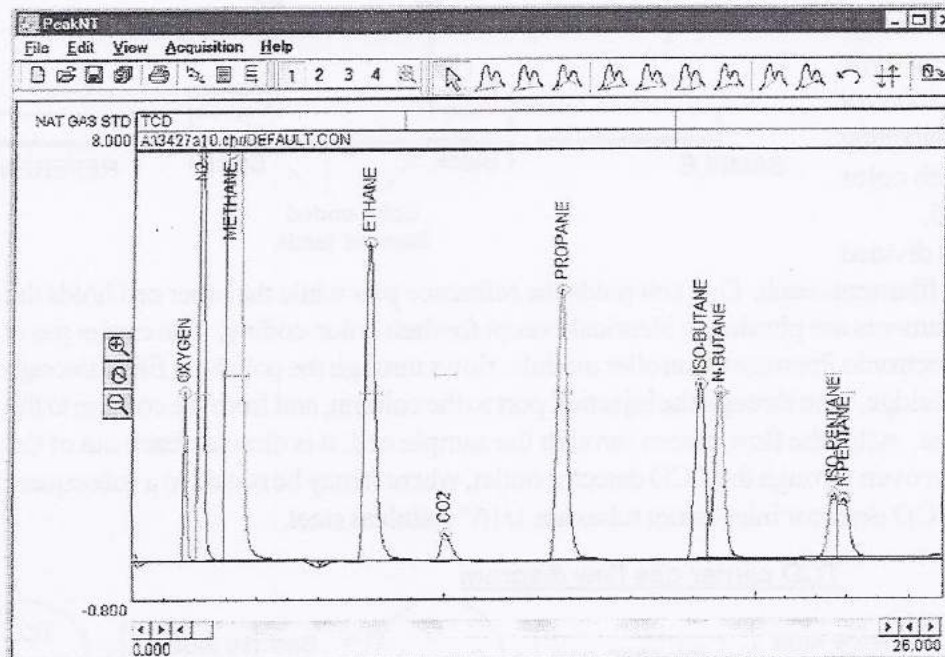

Events:

Time	Event
0.00	ZERO
0.050	G ON (valve inject)
6.00	G OFF

Temperature program:

Initial	Hold	Ramp	Final
40°C	5.00	10.00	220°C
220°C	16.00	0.00	220°C

Results:

Component	Retention	Area
Oxygen	1.633	19.7500
N2	2.150	121.0880
Methane	3.033	563.6130
Ethane	7.550	128.2185
CO2	9.983	11.9860
Propane	13.683	113.9220
Iso-Butane	18.150	69.4960
N-Butane	18.766	67.4460
Iso-Pentane	22.550	20.1490
N-Pentane	22.866	19.1560
Total:		1134.8245

DETECTORS

Thermal Conductivity Detector - TCD

Expected Performance

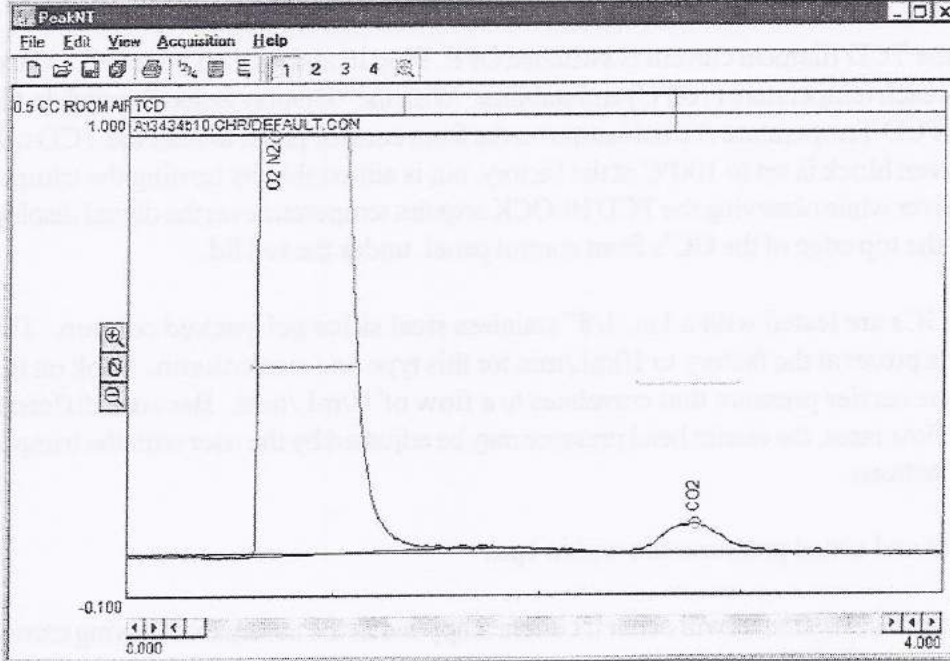

TCD Room Air Analysis

Column: 3' Silica Gel
 Carrier: Helium at 10mL/min
 Sample: 0.5cc room air,
 direct injection
 TCD current: LOW
 TCD temperature: 100°C

Temperature Program:

Initial	Hold	Ramp	Final
80°C	4.00	0.00	80°C

The CO₂ content of the room air analyzed is approximately 350ppm.

Results:

Component	Retention	Area
O ₂ N ₂	0.716	1021.3830
CO ₂	2.766	1.5060
Total		1022.8890

TCD Breath Analysis

Column: 3' Silica Gel
 Carrier: Helium at 10mL/min
 Sample: 0.5cc human breath,
 direct injection
 TCD current: LOW
 TCD temperature: 100°C

Temperature Program:

Initial	Hold	Ramp	Final
80°C	24.00	0.00	80°C

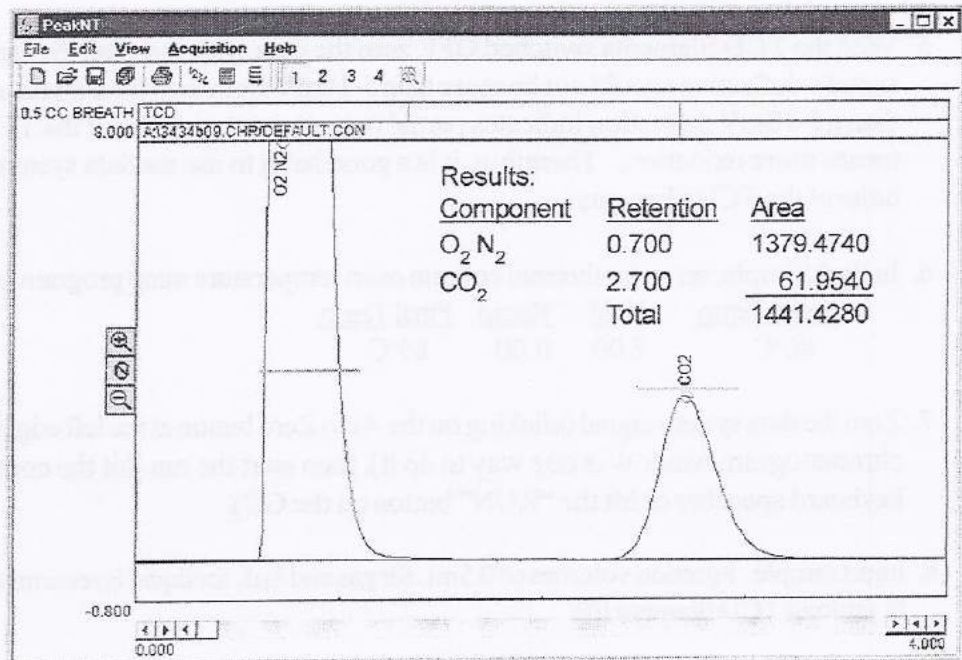

General Operating Procedure

1. Check to make sure that the TCD filament current is switched OFF. Plug in and turn on your GC. Allow the TCD detector oven to reach temperature (100°C) and stabilize. With the "Display Select" switch in the UP position, press on the TCD Temperature Actual button on the front control panel to read the TCD cell temperature. The TCD oven block is set to 100°C at the factory, but is adjustable by turning the trimpot with a small blade screwdriver while observing the TCD BLOCK setpoint temperature on the digital display. The trimpot is located on the top edge of the GC's front control panel, under the red lid.
2. All TCD-equipped SRI GCs are tested with a 1m, 1/8" stainless steel silica gel-packed column. The carrier gas head pressure is preset at the factory to 10mL/min for this type and size column. Look on the right side of the GC for the carrier pressure that correlates to a flow of 10mL/min. Because different columns require different flow rates, the carrier head pressure may be adjusted by the user with the trimpot above the "CARRIER 1" buttons.
3. Make sure that the setpoint and actual pressures are within 1 psi.
4. Damage or destruction of the TCD filaments will occur if current is applied in the absence of flowing carrier gas. ALWAYS verify that carrier gas can be detected exiting the TCD carrier gas outlet BEFORE energizing the TCD filaments. The carrier gas outlet tube is located on the outside of the Column Oven on the same side as the detector. Place the end of the tube in liquid and observe (a little spit on a finger can suffice). If there are no bubbles exiting the tube, there is a flow problem. DO NOT turn on the TCD current if carrier gas flow is not detectable. A filament protection circuit prevents filament damage if carrier gas pressure is not detected at the GC, but it cannot prevent filament damage under all circumstances. Any lack of carrier gas flow should be corrected before proceeding.
5. With the TCD filaments switched OFF, zero the data system signal. Switch the filaments to LOW. The signal's deflection should not be more than 5-10mV from zero for a brand-new TCD detector. Any more than a 5-10mV deflection indicates partial or complete oxidation of the TCD filaments; more deflection means more oxidation. Therefore, it is a good habit to use the data system signal to check the working order of the TCD filaments.
6. In PeakSimple, set an isothermal column oven temperature ramp program as follows:

<u>Initial Temp.</u>	<u>Hold</u>	<u>Ramp</u>	<u>Final Temp.</u>
80°C	7.00	0.00	80°C
7. Zero the data system signal (clicking on the Auto Zero button at the left edge of the chromatogram window is one way to do it), then start the run (hit the computer keyboard spacebar or hit the "RUN" button on the GC).
8. Inject sample. Injection volumes of 0.5mL for gas and 1µL for liquid is recommended to prolong TCD filament life.

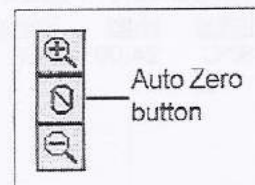

TCD Troubleshooting

When the TCD fails to perform normally, review operating conditions to ensure that carrier gas flow to the detector is unimpeded, and that the column oven temperature, carrier gas flow rate, and carrier gas EPC pressure are all within the desired operating parameters. If all conditions are properly met and the detector continues to perform poorly or fails to perform at all, check the TCD filaments for damage. The main diagnostic test is to measure the resistance of each filament using the ohmmeter function of a multimeter or volt-ohmmeter (VOM). At room temperature, the resistance of each filament should be 32-34 ohms. At 100°C, the filaments are around 40 ohms each. If any filament is significantly different from the others, the TCD bridge will be unbalanced, noisy and drifts. All eight filament wires must be disconnected and tested. Since all the leads are bundled together as they exit the TCD detector assembly, you may need to use the multimeter or VOM to determine the actual pairs. It is normal for each filament to have a slightly different reading within the appropriate operating range, so match the readings to determine the lead pairs.

With the power turned off and the power cord unplugged from the electrical outlet, raise the red lid to access the TCD detector. Exiting the right side of the TCD detector oven is the bundle of 8 insulated, color-coded wires in pairs. Each pair of wires represents one filament and is connected to the appropriately labeled terminal for its paired colors. One filament has red/green, one red/blue, one black/green, and one black/blue. The red/green and black/blue are the sample side filaments, and the ones which typically deteriorate first. Remove the 8 wires from the bridge terminal by loosening the retaining setscrews with a small blade screwdriver. Measure the resistance across the filament leads using an ohmmeter, making sure the correct pair of colored wires is tested together for each filament. An infinite reading is an indication that the filament is open, or burned out. If any of the filaments has a significantly different resistance than the others (which should be in the ranges mentioned above), it should be replaced. Replacement filaments, o-rings, and TCD blocks with four new filaments are available from SRI. In addition to the standard filaments, optional gold-plated filaments for improved corrosion resistance are also available.

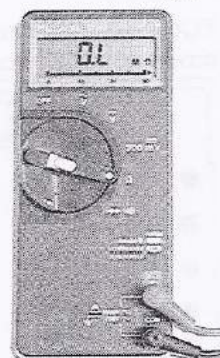
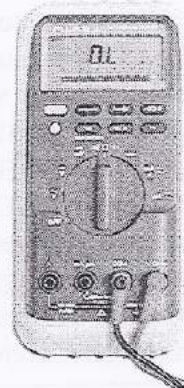

Many multimeters are available; these two are from Fluke Corporation:
USA: 1-800-44-FLUKE
EU: (31 40) 2 678 200
www.fluke.com

SRI TCD detector replacement parts

Standard TCD filament with rubber O-ring gasket
High temperature TCD filament with copper gasket

8670-9120
8690-9123

(filament part #s are also listed on the top of the TCD oven in your SRI GC)

DETECTORS

Thermal Conductivity Detector - TCD

Replacing the TCD Filaments

SRI TCD detectors are made to last a long time without ever replacing the filaments. However, any TCD filaments that fail the diagnostic ohmmeter test mentioned previously will have to be replaced. While they share the same outer assembly, there are a few differences between the high temperature TCD detector block and the standard TCD block. Both designs are discussed. All filaments are fragile; handle them with care. Have colored ink pens, electrical tape, whatever you will use for color coding close at hand before you begin. It is best to go slowly, color-coding then replacing each filament one at a time. **IF YOU MIX UP THE FILAMENT LEADS, YOUR TCD WILL NOT WORK!**

A. Standard TCD detector block access

1. With a small blade screwdriver, free the filament leads from the bridge terminal by loosening the setscrews.
2. Remove the detector assembly cover by unscrewing the thumbscrew then sliding the cover off toward the right-hand edge of the GC; gently remove the white insulation to reveal the detector block.
3. Disconnect the detector block gas inlets and outlets. The reference gas inlet is disconnected at the polishing filter immediately behind the column oven. The reference gas outlet is disconnected inside the column oven. Disconnect the sample gas inlet at the fitting on the column. The detector block sample gas inlet tubing has a copper sheath for identification. The sample gas outlet is usually routed out the right side of the column oven.

Exploded view of the standard TCD detector assembly

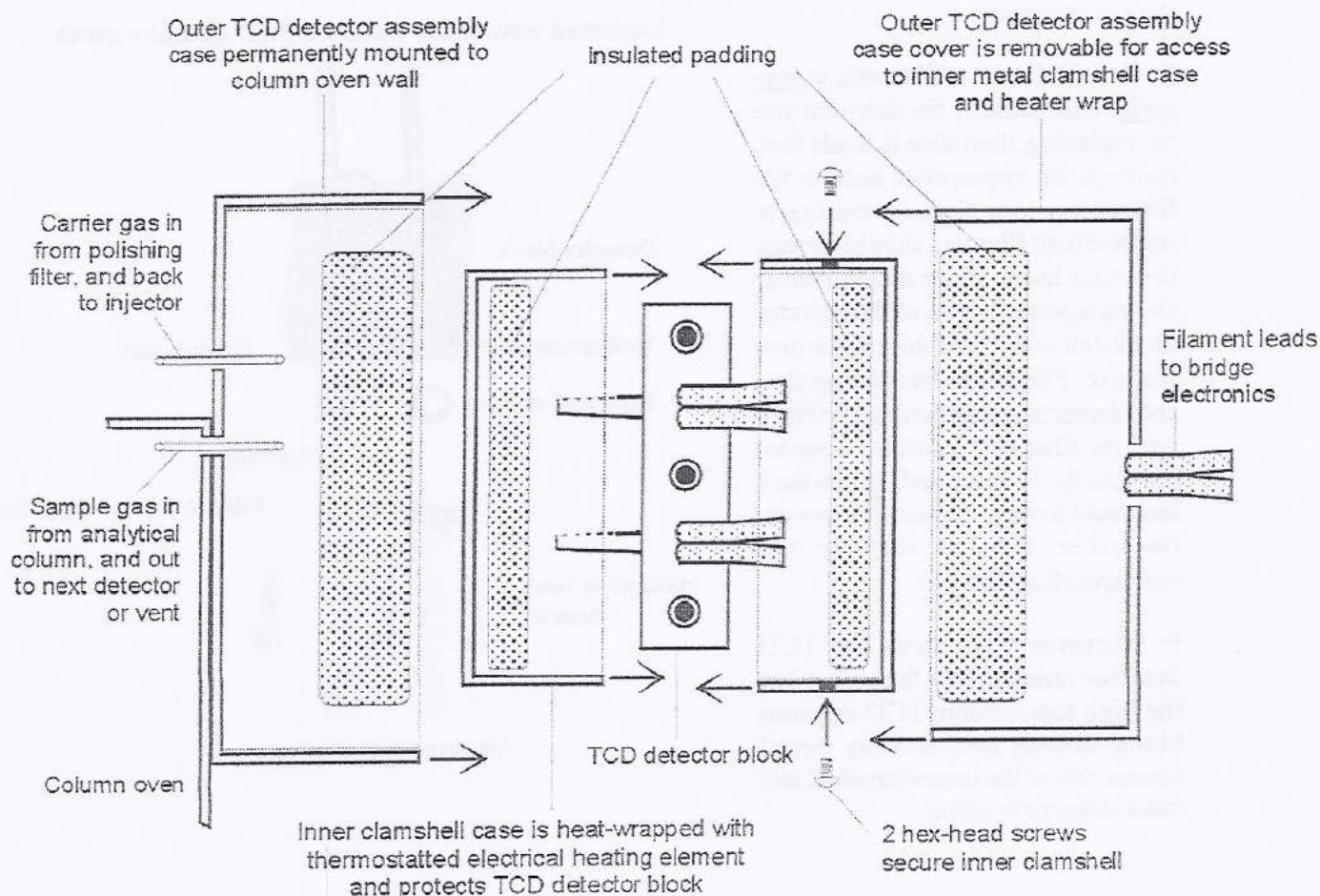

DETECTORS

Thermal Conductivity Detector - TCD

Replacing the TCD Filaments continued

(Standard TCD detector block access continued)

4. Cut the fiberglass tape wrapped around the detector block and peel it off. Unwrap and remove the heater rope from the detector block (it is probably affixed to the thermocouple wires with more fiberglass tape).

5. Disconnect the thermocouple by loosening the small philips head screw which holds it on the detector block clamshell. Next, remove the clamshell by unscrewing the two small philips head screws that hold its halves together. Gently remove the white insulation to reveal the detector block.

6. The TCD filaments are secured in the detector block by two plates, each of which is held in place with three hexagonal head screws. Holding the detector block with one hand, use an Allen wrench to unscrew and remove the hexagonal head screws from one of the filament securing plates. Then, slide the filament securing plate off the filaments and leads. Set it securely aside.

7. Once the securing plate is removed, the filament and rubber O-ring that seals it can be gently pulled out of the detector block cell. When replacing a filament, its rubber O-ring should also be replaced. Check the lip of the detector block cell for fragments of the old O-ring and if any are present, remove them as they will interfere with proper sealing of the cell. If you're replacing one reference or sample filament, replace the other at the same time. If you didn't have fun disassembling the TCD detector block, replace all the filaments while you have it open. It's a good idea to remove then replace one plate and corresponding pair of filaments at a time to avoid mixing up their connections.

8. To install a new filament, **color-code** it the same as the filament you are replacing, then slide it, leads first, through the appropriate hole in the filament securing plate. An existing or replacement filament should occupy the other hole. Place a new rubber O-ring against the rim of the detector block cell which will accept the new filament. Place filament securing plate and filaments against the detector block with the filaments inside the detector block cells. Replace and tighten the 3 hex-head screws. Repeat this process on other side to replace the corresponding filament.

9. Reverse your steps for TCD detector reassembly. Steps 7-10 of the high temperature TCD detector block access instructions detail reassembly of the inner clamshell and outer detector housing.

Exploded view of the standard TCD detector block

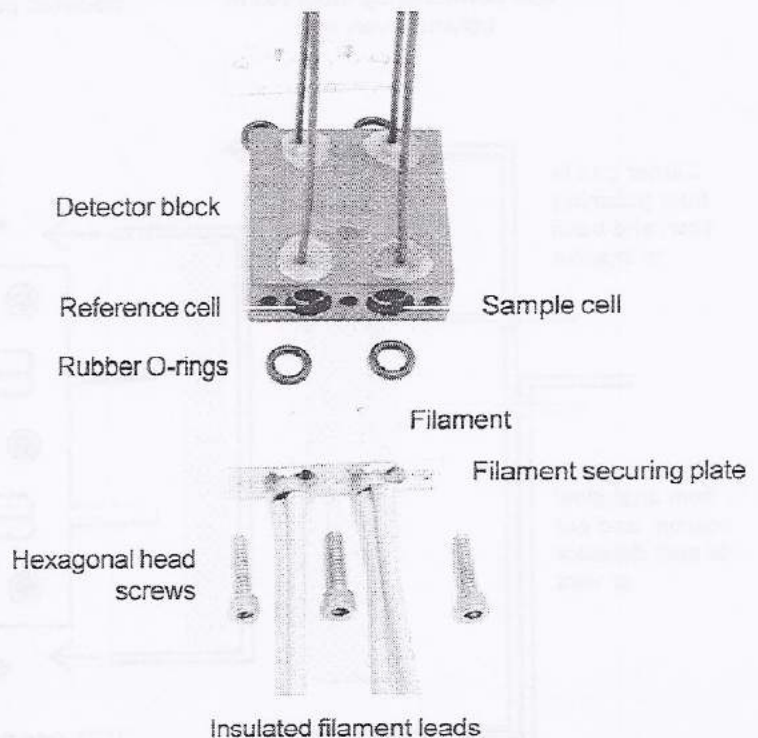

DETECTORS

Thermal Conductivity Detector - TCD

Replacing the TCD Filaments continued

B. High temperature TCD detector block access

The high temperature TCD assembly is the same as the standard: outer housing around an inner clamshell case. The high temp detector block uses gland nuts and copper gaskets to secure the four filaments in its two cells. Instead of the heater rope, it employs a heating cartridge, which is inside the inner clamshell case with the detector block.

1. With a small blade screwdriver, disconnect the filament leads from the bridge terminal by loosening the setscrews.

2. Remove the detector housing by unscrewing the thumbscrew then sliding the housing cover off toward the right-hand edge of the GC. Gently remove the white insulation to reveal the detector block.

3. Disconnect the detector block gas inlets and outlets. The reference gas inlet is disconnected at the polishing filter immediately behind the column oven. The reference gas outlet is disconnected inside the column oven. Disconnect the sample gas inlet at the fitting on the column. The detector block sample gas inlet tubing has a copper sheath for identification. The sample gas outlet is usually routed out the right side of the column oven. Once these three fittings are loosened and the detector block tubing freed, gently pull the detector block away from the housing.

Exploded view of high temperature TCD detector block and inner clamshell

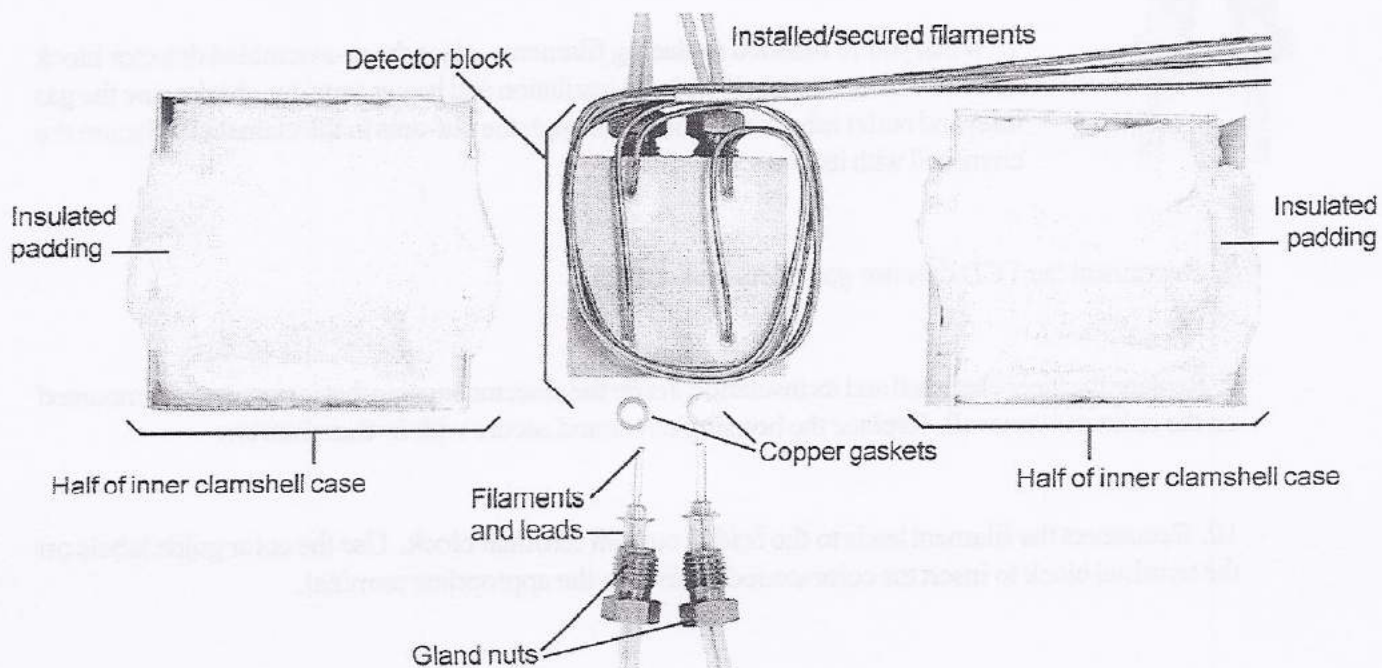

Replacing the TCD Filaments continued

(High temperature TCD detector block access continued)

4. Open the inner clamshell case by unscrewing the two small philips head screws that hold the two halves together. Gently remove the white insulation to access the detector block.

5. The filaments are held in place by gland nuts; loosen these nuts to remove the filaments and copper gaskets. **Color-code** the new filament the same as the one you are replacing (you can use colored marker pens, electrical tape, etc.) before completely removing the old one. Slide the gland nut off the existing filament, toward the ends of the filament leads.

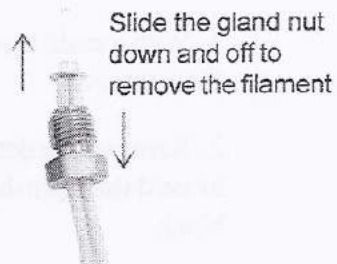

6. Put the new filament's leads through the gland nut. Slide the gland nut up the filament's leads until it rests against the base of the filament. Place the copper gasket against the rim of the detector block cell opening. Carefully insert the filament and gland nut together into the cell opening. Tighten the gland nut to secure the filament in the cell.

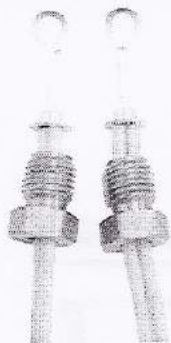

7. When you're finished replacing filaments, place the re-assembled detector block inside the inner clamshell with the insulation and heater cartridge. Make sure the gas inlet and outlet tubes are running through the cut-outs in the clamshell. Secure the clamshell with its two screws.

8. Reconnect the TCD detector gas inlets and outlets.

9. Replace the inner clamshell and its insulation inside the detector housing that is permanently mounted on the column oven wall. Replace the housing cover and secure with its thumbscrew.

10. Reconnect the filament leads to the bridge current terminal block. Use the color guide labels on the terminal block to insert the color-coded leads into the appropriate terminal.

As illustrated by the table below, Helium and Hydrogen have the highest thermal conductivities of any gases. The TCD detector responds to the difference between the thermal conductivity of the carrier gas and the analyte peak. The greater the difference, the better the sensitivity. For this reason, Nitrogen is only used as a carrier gas when hydrogen or helium is the target analyte. Argon is sometimes used as a carrier gas, but would have little sensitivity towards ethane or propane, for example, because the thermal conductivity of the argon (39) is very close to that of ethane (43) or propane (36).

THERMAL CONDUCTIVITIES OF SOME COMMON GASES

Air	58
Argon	39
CO	53
CO ₂	34
H ₂	419
HE	343
N ₂	57
O ₂	58
Neon	109
Methane	73
Ethane	43
Propane	36
Butane	32

DETECTORS

Flame Ionization Detector - FID

Overview

The Flame Ionization Detector responds to any molecule with a carbon-hydrogen bond, but its response is either poor or nonexistent to compounds such as H_2S , CCl_4 , or NH_3 . Since the FID is mass sensitive, not concentration sensitive, changes in carrier gas flow rate have little effect on the detector response. It is preferred for general hydrocarbon analysis, with a detection range from 0.1 ppm to almost 100%. The FID's response is stable from day to day, and is not susceptible to contamination from dirty samples or column bleed. It is generally robust and easy to operate, but because it uses a hydrogen diffusion flame to ionize compounds for analysis, it destroys the sample in the process.

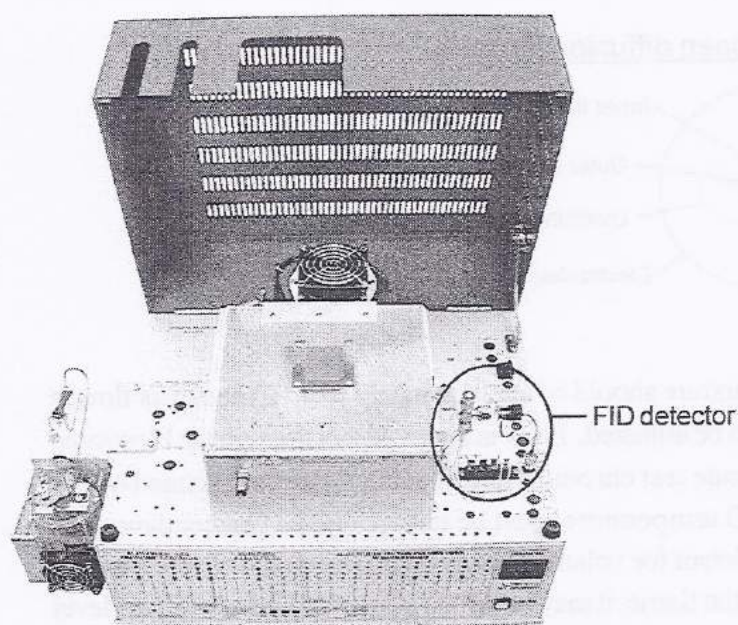

(SRI Capillary FID GC with built-in Hydrogen Generator)

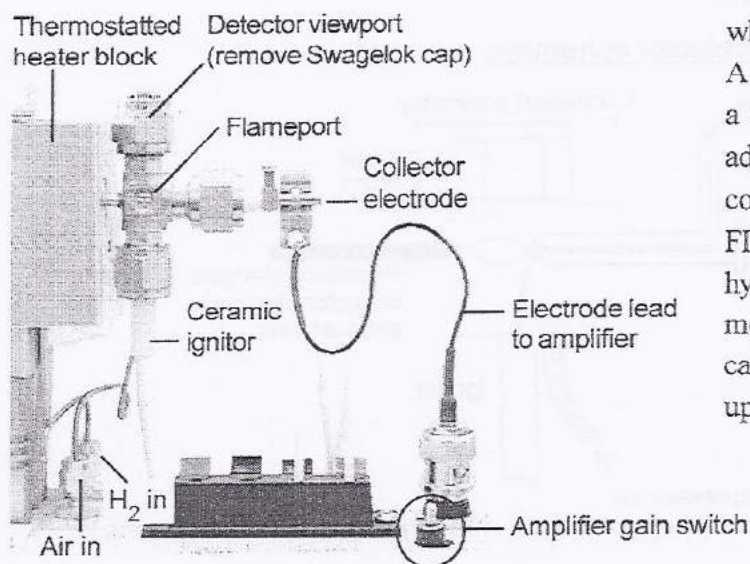

The SRI FID features a unique ceramic ignitor which can run hot continuously, and prevent the flame from extinguishing even with large water injections or pressure surges from column backflush. This ignitor is positioned perpendicular to the stainless steel detector jet and does not penetrate the flame. Opposite this flame is the collector electrode. This positively charged metal tube serves as a collector for the ions released as each sample component elutes from the column(s) and is pyrolyzed in the flame; it doubles as a vent for the FID exhaust gas. The FID is equipped with an electrometer amplifier which has HIGH, HIGH (filtered), and MEDIUM gain settings. On an SRI GC, the hydrogen and air gas flows are controlled using electronic pressure controllers, which are user adjustable via the GC's front panel. A thermostatted aluminum heater block maintains a stable detector temperature which is user adjustable up to 375°C. The optional built-in air compressor may be used to supply the air for the FID, eliminating bulky air cylinders. The built-in hydrogen generator is another option: the standard model can produce 20 mL/min for use as both carrier gas and FID combustion gas at pressures up to 25 psi.

DETECTORS

FID - Flame Ionization Detector

Theory of Operation

In the SRI FID, the carrier gas effluent from the GC column is mixed with hydrogen, then routed through an unbreakable stainless steel jet. The hydrogen mix supports a diffusion flame at the jet's tip which ionizes the analyte molecules. Positive and negative ions are produced as each sample component is eluted into the flame. A collector electrode attracts the negative ions to the electrometer amplifier, producing an analog signal for the data system input. An electrostatic field is generated by the difference in potential between the positively charged collector electrode and the grounded FID jet. Because of the electrostatic field, the negative ions have to flow in the direction of the collector electrode.

The FID hydrogen diffusion flame

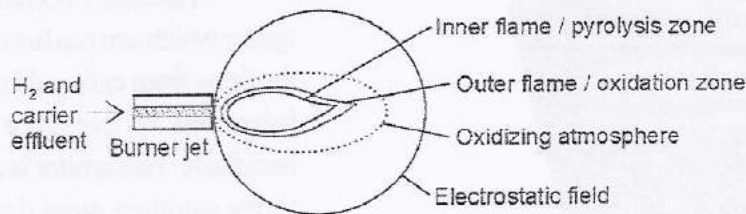

The ratio of air to hydrogen in the combustion mixture should be approximately 10:1. If the carrier flow is higher than normal, the combustion ratio may need to be adjusted. Flow is user adjusted through the Electronic Pressure Controllers (EPC); the rates used to generate test chromatograms at the factory are printed on the right side of the GC in the flow rate chart. The FID temperature must be hot enough so that condensation doesn't occur anywhere in the system; 150°C is sufficient for volatile analytes; for semi-volatiles, use a higher temperature. In addition to using the ignitor to light the flame, it may be left on at an intermediate voltage level to prevent flameout (-750 or 7.5 volts). The ignitor is very durable and will last a long time, even at high temperatures.

FID detector schematic

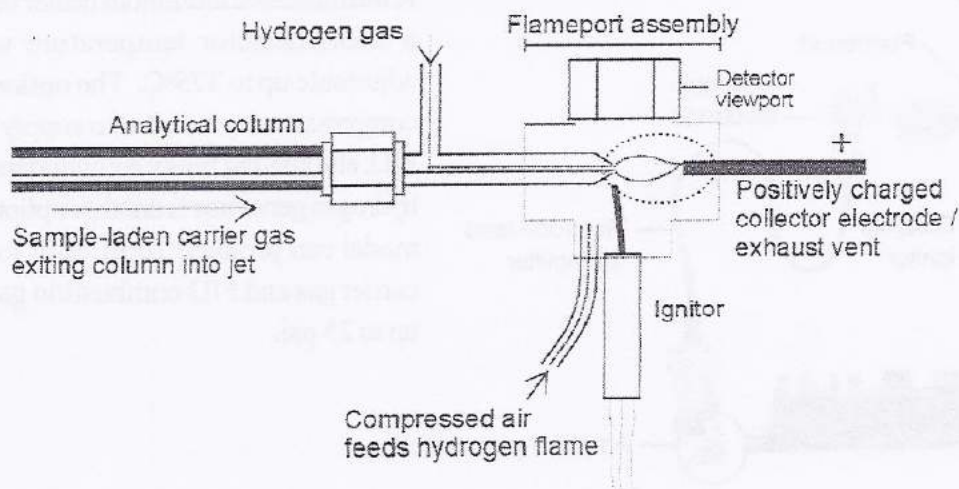

Expected Performance

FID noise run

Column: 15m MXT-1
 Carrier: Helium @ 10mL/min
 FID gain = HIGH
 FID temp = 150°C
 FID ignitor = -400

Temperature program:

Initial	Hold	Ramp	Final
80°C	15.00	0.00	80°C

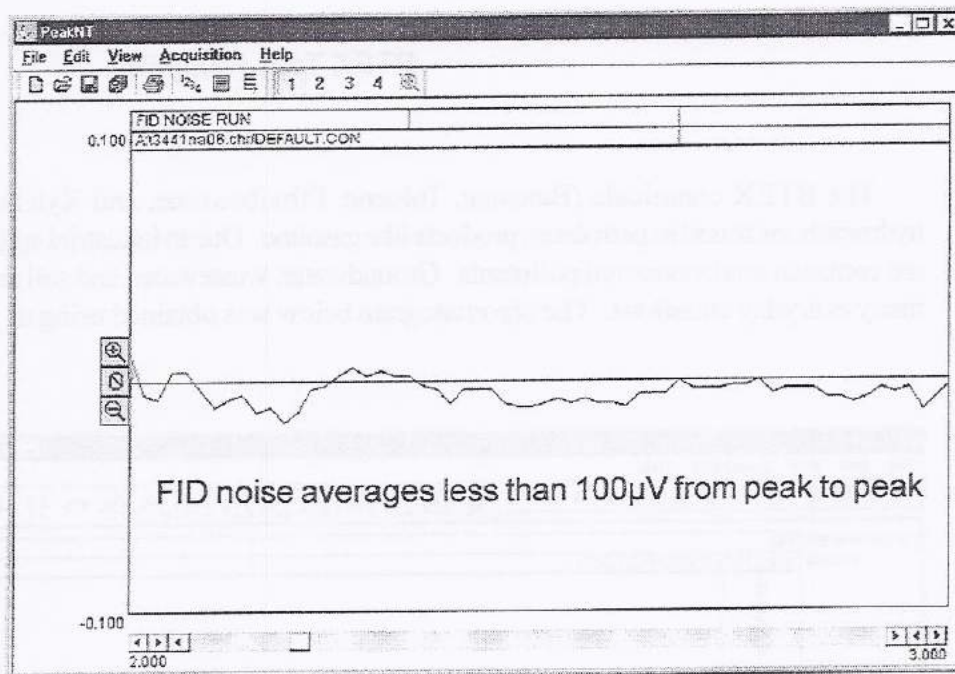

C₁-C₆ Hydrocarbon Test Analysis

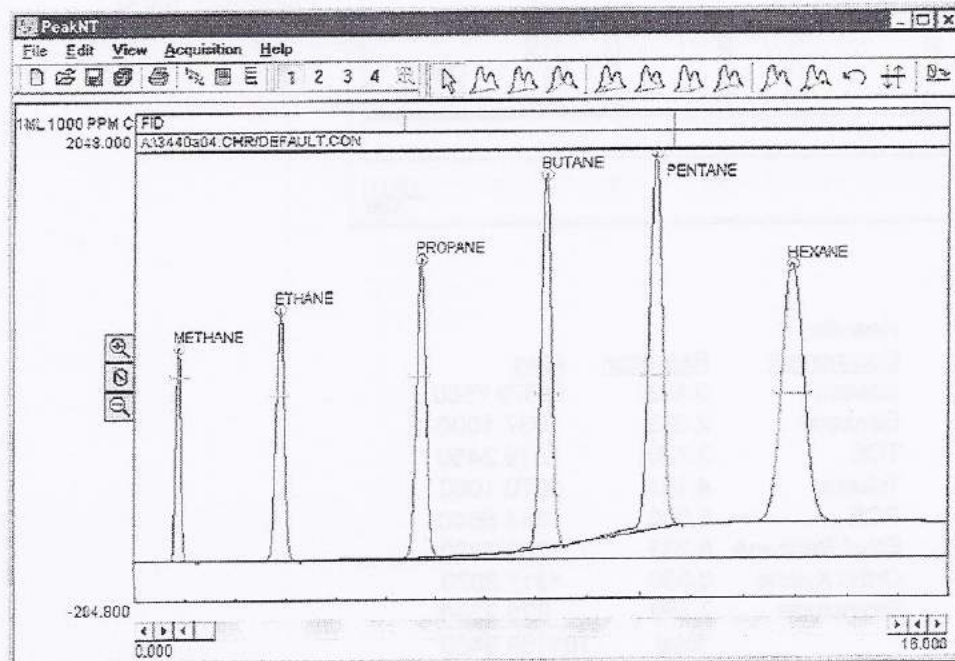

Sample: 1mL of 1000ppm C₁-C₆
 Carrier: Helium @ 10mL/min
 FID H₂ at 25psi = 25mL/min
 FID air at 6psi = 250mL/min
 FID temp = 150°C
 FID ignitor = -750
 FID gain = HIGH
 Valve temp = 90°C

Results:

Component	Retention	Area
Methane	0.850	6979.9260
Ethane	2.866	13623.7580
Propane	5.683	19535.8960
Butane	8.200	26456.5980
Pentane	10.283	33053.9680
Hexane	12.916	39419.0870
Total		139069.2330

DETECTORS

FID - Flame Ionization Detector

Expected Performance

BTEX Test Analysis

The BTEX chemicals (Benzene, Toluene, Ethylbenzene, and Xylenes) are volatile monoaromatic hydrocarbons found in petroleum products like gasoline. Due to industrial spills and storage tank leakage, they are common environmental pollutants. Groundwater, wastewater, and soil are tested for BTEX chemicals in many everyday situations. The chromatogram below was obtained using an FID-equipped SRI GC.

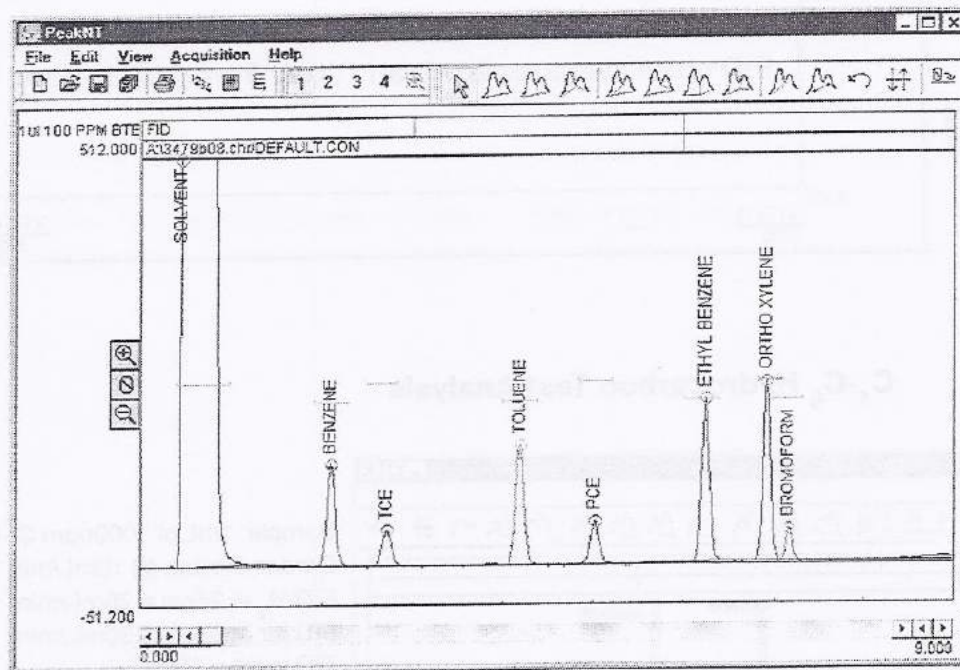

1 μ L 100ppm BTEX sample

15m MXT-VOL capillary column

FID gain = HIGH
FID temp = 150°C
FID ignitor = -400

Results:

Component	Retention	Area
Solvent	0.433	95879.7560
Benzene	2.083	837.1000
TCE	2.700	319.2450
Toluene	4.183	1070.1060
PCE	5.000	344.8640
Ethyl Benzene	6.233	1200.3320
Ortho Xylene	6.900	1312.3070
Bromoform	7.150	225.2360
total		101188.9460

DETECTORS

FID - Flame Ionization Detector

General Operating Procedure

1. Set the FID amplifier gain switch to HIGH for most hydrocarbon applications. If peaks of interest go off the scale (greater than 5000mV), set the gain to MEDIUM. When peaks of interest are 20 seconds wide or more at the base and extra noise immunity is desired, set the gain switch to HIGH (filtered). This setting broadens the peaks slightly.

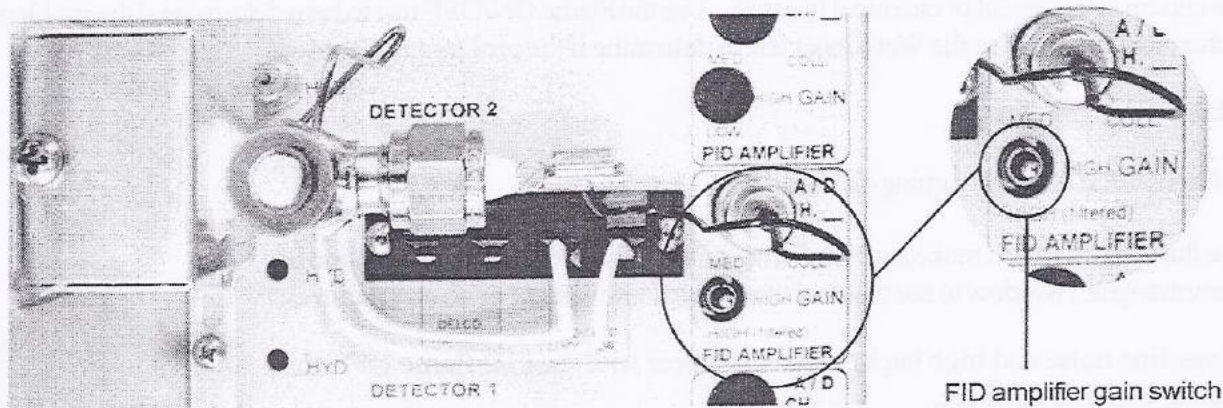

2. Set the FID hydrogen flow to 25mL/min, and the FID air supply flow to 250mL/min. The approximate pressures required are printed in the gas flow chart on the right-hand side of the GC.

3. Ignite the FID by holding up the ignitor switch for a couple of seconds until you hear a small POP. The ignitor switch is located on the front panel of your SRI GC under the "DETECTOR PARAMETERS" heading (it is labelled vertically: "FLAME IGNITE").

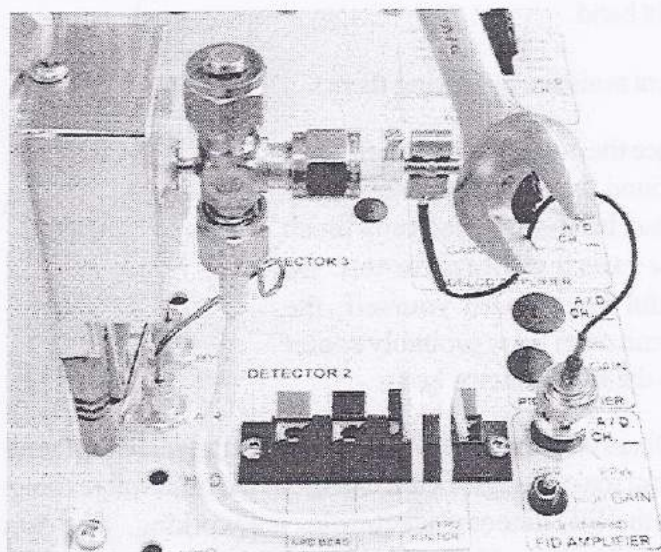

4. Verify that the FID flame is lit by holding the shiny side of a chromed wrench directly in front of the collector outlet/FID exhaust vent. If condensation becomes visible on the wrench surface, the flame is lit.

5. If you wish to keep the ignitor ON to prevent flameout, set the ignitor voltage to -750 by adjusting the trimpot on the "FLAME IGNITE" zone with the supplied screwdriver.

DETECTORS

Flame Ionization Detector - FID

FID Troubleshooting

Whenever you experience problems with your FID, review your operating procedures: check the detector parameters, check to make sure you are on the correct channel of the data system display, check the mixture of hydrogen (25mL/min) and air (250mL/min), check gas pressures and connections, check the oven and detector temperatures, and all the other variables that compose your analysis. Having ruled out operating procedure as the source of the problem, there are two simple diagnostic tests you can perform. Detector problems can be electrical or chemical in nature. Use the Flame ON/OFF test to help determine if the problem is of chemical origin. Use the Wet Finger test to determine if the problem is electrical.

A. Flame ON/OFF Test

1. Extinguish the flame by turning off the air.
2. Use the wrench test to make sure the flame is OFF. If it is, observe the baseline in the chromatogram window to see whether there is an improvement or no change at all.
3. If baseline noise and high background disappear with the FID flame OFF, the problem is chemical in nature.
4. Isolate the column by capping off the column entrance to the detector with a swagelok-type cap or a nut and septum. Turn the air back on and light the FID flame. If the detector noise is similar to the background that was observed with the flame OFF, the column is suspect.



B. Wet Finger Test

1. Make a V sign with the first two fingers of your right hand.
2. Moisten those two fingers (you can achieve sufficient moisture by licking them).
3. Place one finger on the collector electrode, and place the other on bare metal (like the FID detector body or the column oven lid) to ground the collector. Make your contact brief--you need only brush these parts to perform the test. Be careful not to burn yourself; the column oven lid is probably cooler than the FID detector body.

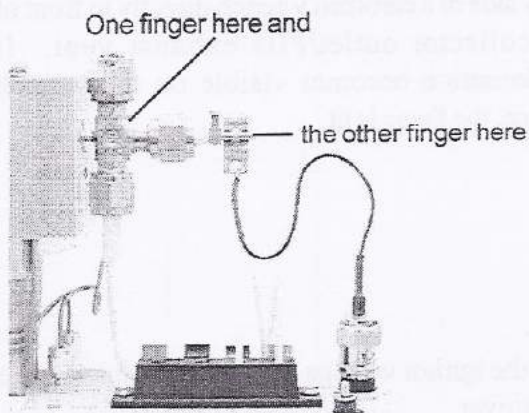

5. Observing the milliVolt reading on the screen. If your contact makes a significant change in the milliVolt reading, then the FID detector electronics are working. The data system signal should jump from zero to the maximum voltage (5,000mV), then come back down when you remove your fingers.

Cleaning the FID

The FID detector rarely requires cleaning or servicing. It may develop a film or coating of combustion desposits in the flameport with extended use. Use the FID detector viewport to check for visible deposits. If you're experiencing problems with your FID detector, try cleaning it, even if you can't see deposits through the viewport.

1. Unscrew the viewport cap nut and examine the flameport interior for coatings or films. If residue is found, the collector electrode and the flameport will need cleaning.

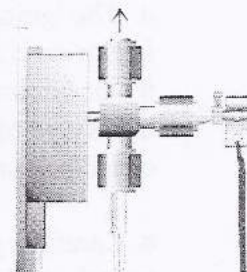

2. Remove flameport assembly from the heater block

a. Disconnect the FID air supply line at the 1/16" bulkhead fitting.

b. Using a philps head screwdriver, remove the screw on the top of the FID's heater block and pull the aluminum cover up and off.

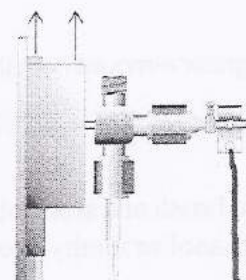

c. Gently pull off the white insulation to reveal the detector's bulkhead fitting on the column oven wall. Loosen this fitting to disconnect the flameport.

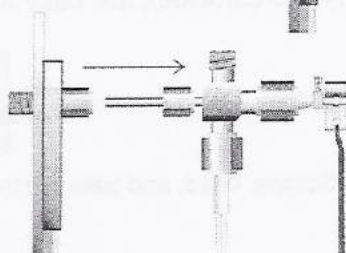

3. Remove the collector electrode

a. Unclip the electrode lead terminal and slide it off the electrode.

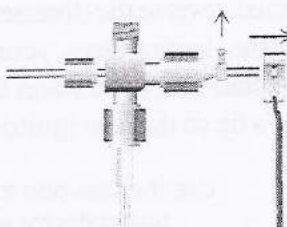

b. Loosen and remove the nut and ferrule that hold the collector electrode in the flameport body.

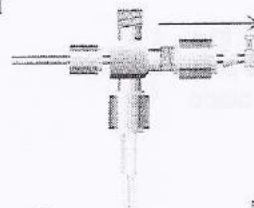

c. Slide the collector electrode out of the nut. Once removed, spin it between your fingers in a piece of sandpaper to clean the stainless steel surface. A wire brush may also be used to scrub the electrode. Once cleaned, set it aside with the ignitor.

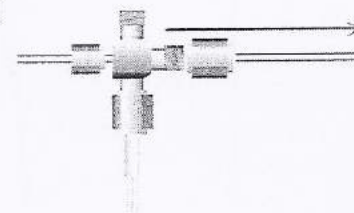

DETECTORS

Flame Ionization Detector - FID

Cleaning the FID continued

4. Remove the FID ignitor element

a. The ignitor element is brittle and will break when stressed, so handle the ignitor carefully, mindful of any torque on the blades. While holding the ignitor by the ceramic body with one hand, loosen the 1/4" swagelok-type nut that holds it in place. There is a graphite ferrule inside this nut that secures the ceramic ignitor body when the nut is tightened.

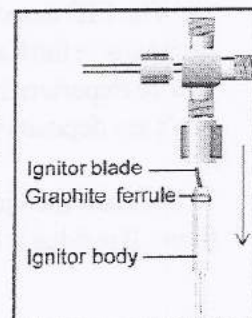

b. Carefully pull the ignitor down out of the flameport. Disconnect the ignitor from the spring-loaded ignitor current source terminals. Set the ignitor securely aside.

FID ignitor removed from the flameport assembly

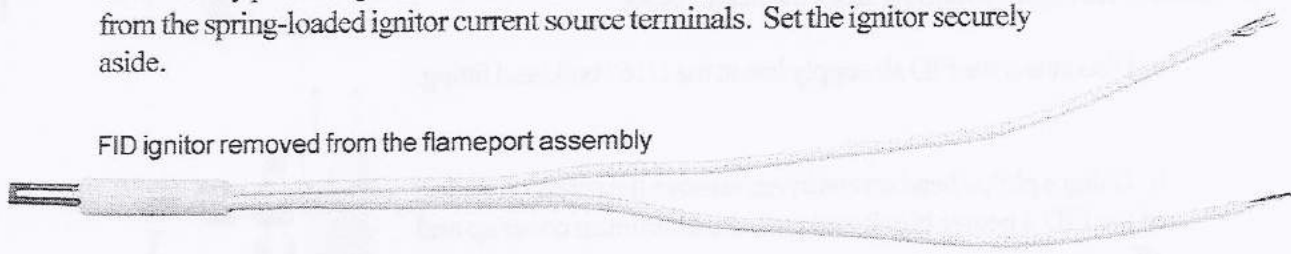

5. Use a wire brush or a sharp object to remove any residue from the flameport interior, then rinse it with solvent (methanol or methylene chloride), and bake it out in the GC's column oven at 250°C for 10-15 minutes.

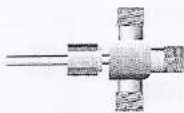

Scrape, rinse, and bake out the FID flameport interior

6. Re-assembly

a. Once all the FID parts are cleaned, reverse the disassembly process, starting with the replacement of the ceramic ignitor. Leaving out the cleaning steps, your last step should be reinstalling the flameport assembly onto the heater block. Make sure to position the ignitor so that the blade is slightly below and angled 10-15° toward the jet's tip so that the ignitor will not interfere with the flame or create turbulence.

Use the viewport to correctly position the FID ignitor and collector electrode inside the flameport

FID ignitor removed from the flameport; note the slight angle of the blade element

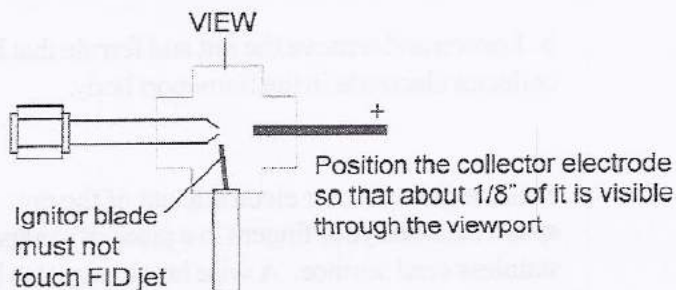

Chapter: FID DETECTOR

Topic: Operation of FID detector without hydrogen (FLID mode)

There are situations where it would be helpful to operate the FID detector using just the built-in air compressor for carrier gas and no other gases. SRI distributors demonstrating the GC and software may find it useful to run live chromatograms without the inconvenience of providing hydrogen and helium. Service personnel troubleshooting other GC functions may be able to test the GC without gases, and under some circumstances, the response of the flameless ionization detector (FLID) may actually be useful for non-quantitative applications.

The FID detector is normally located on the right hand side of the column oven.

The FID normally requires a flow of 20-30 ml/min of hydrogen and 200-300 ml/min of air to support a hydrogen flame at the tip of the jet. The heat of the flame ionizes the analyte molecules, and the negative ions allow a small electric current to flow between the collector electrode and the grounded flame jet. The ignitor normally serves only to ignite the flame.

The FID detector body is shown at right in the normal configuration, but removed from the detector heating block on the GC for clarity.

Inside the FID detector body, the ignitor is normally positioned just below and behind the tip of the jet. Notice that the ignitor blade is tilted at a 15 degree angle from the ceramic tube in which it is fabricated. In normal FID operation, the ignitor is positioned below and behind the jet so it will not disrupt or distort the flame, yet close enough to easily ignite the hydrogen/air mixture.

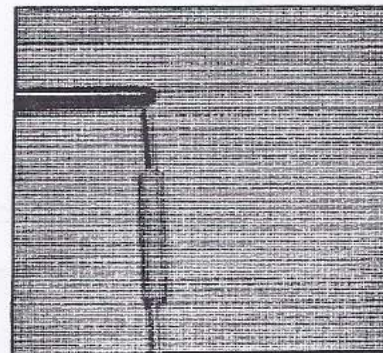
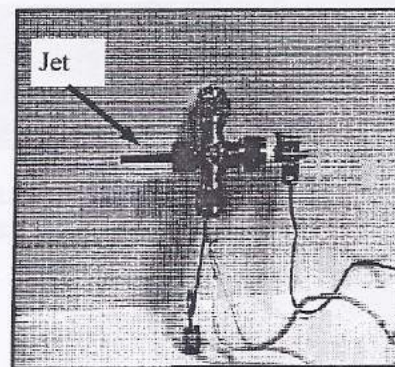
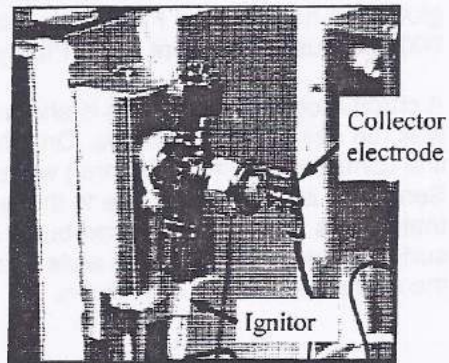
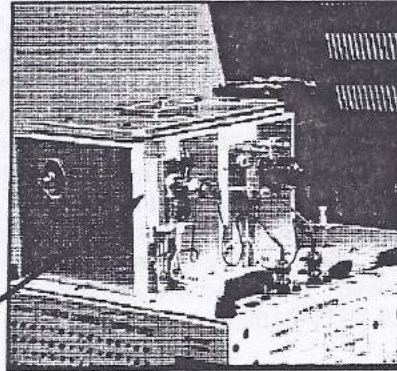

Chapter: FID DETECTOR

Topic: Operation of FID detector without hydrogen (FLID mode)

In the FLID mode, the ignitor itself provides the heat necessary to ionize the sample molecules. Accordingly, the ignitor needs to be positioned directly in front of the jet. The slight angle of the ignitor allows the ignitor tip to be located 1-2 mm in front and slightly above the jet. The ignitor is held in place by a soft graphite ferrule and a swagelok nut. Be careful when manipulating or twisting the ignitor because the ignitor blade is very brittle ceramic, and will snap if stressed. Replacement ignitors are available using part# 8670-0150.

The ignitor temperature must be raised so that it glows red hot. Set the FID ignitor volts to at least 900-1000 using the front panel FID ignitor control.

A chromatogram of gasoline is shown below which was run using the FLID mode. Only the larger gasoline components (> 1000 ppm) were detected. Sensitivity is exponential due to the temperature rise that occurs when the peak combusts on the ignitor surface. Large peaks which elute quickly may cool the ignitor resulting in split peaks.

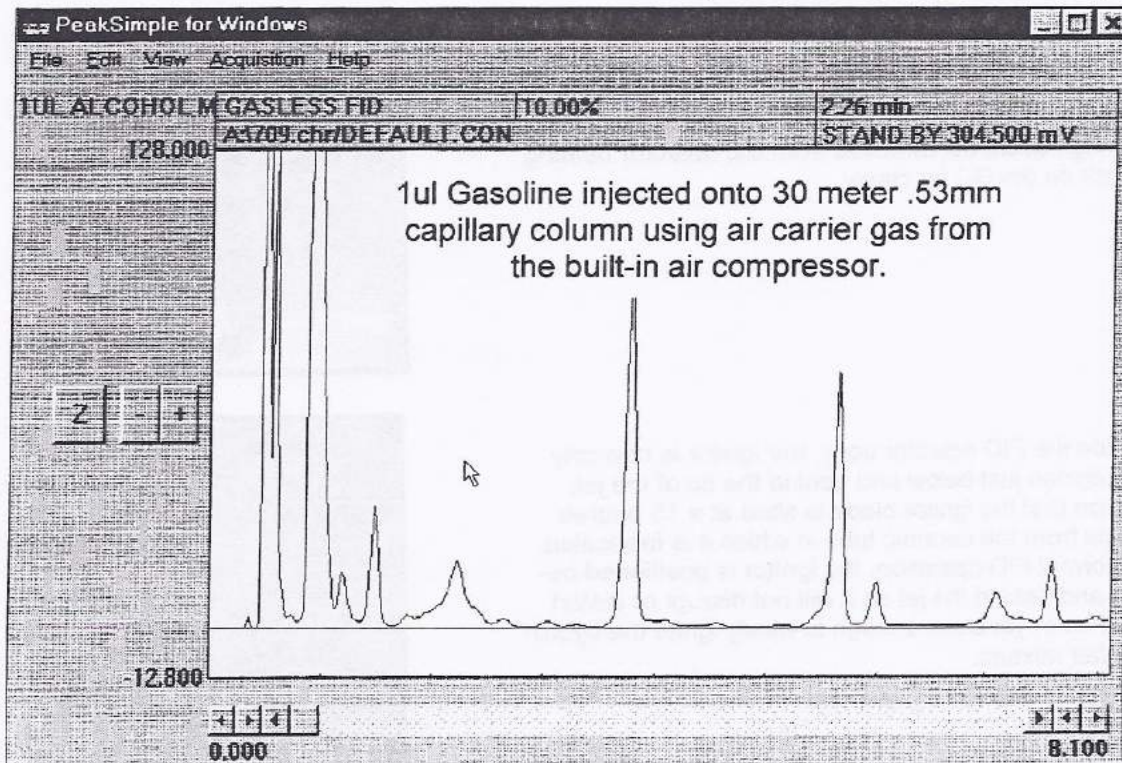
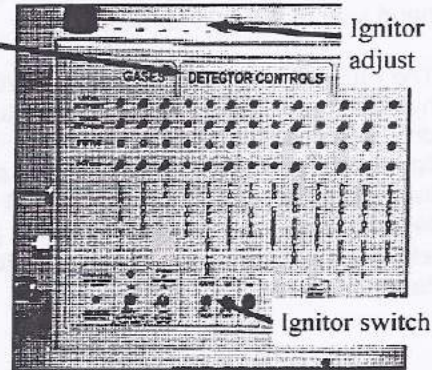
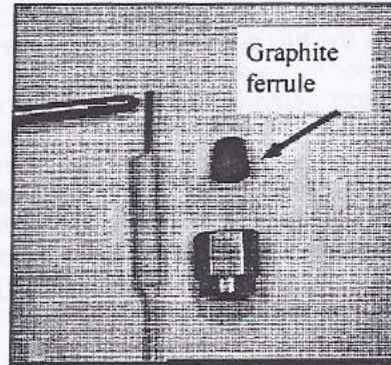

Chapter: Detectors

Topic: Converting from FID to NPD mode

To convert the FID detector to NPD detector:

1) The FID and NPD detectors are almost identical. The detector body is mounted on a heated aluminum block on the right hand side of the GC oven.

The NPD body is slightly different from the FID in that the NPD flame jet does not protrude as far from the detector body as it does on the FID. This allows the NPD thermionic bead to be positioned directly in front of the jet. Remove the FID body from the heated aluminum block and replace it with the NPD body.

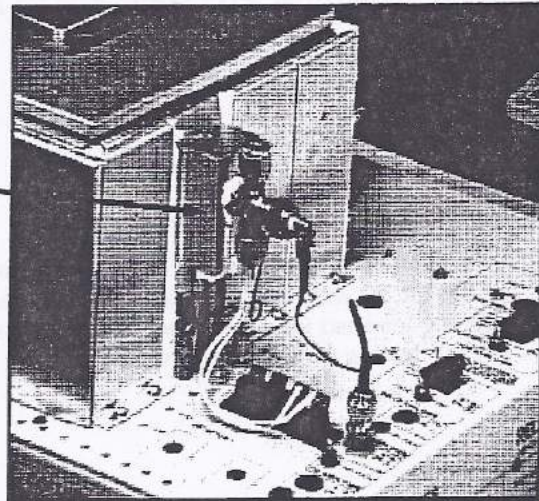

2) The photo at right shows the FID/NPD detector body and both the FID ignitor and NPD thermionic bead side by side for comparison. Both the FID ignitor and NPD thermionic bead are inserted into the detector body from the bottom. The ignitor is inserted until the tip of the ignitor is just below the tip of the flame jet, while the NPD bead is inserted until the heated part of the bead is directly in front of the flame jet. For NPD operation, the sample molecules must collide with the bead in order to be ionized and detected.

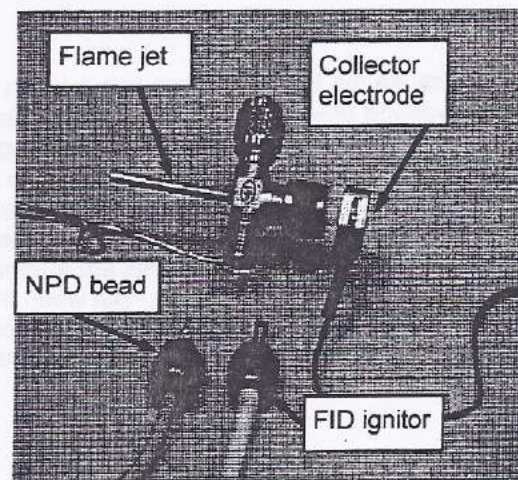

3) The gas flows to the NPD detector are different than the FID gas flows. The NPD hydrogen flow is normally about 3 ml/min while the FID hydrogen flow is about 25ml/min. To obtain this lower H₂ flow rate, an additional restrictor coil is attached to the hydrogen bulkhead fitting immediately below the detector body. With this additional restrictor coil in place, 10 psi hydrogen pressure will result in a flow rate of about 3ml/min. The NPD air flow rate is typically about 100 ml/min, but this flow rate can be achieved by simply reducing the air pressure from 8 psi to about 3 psi.

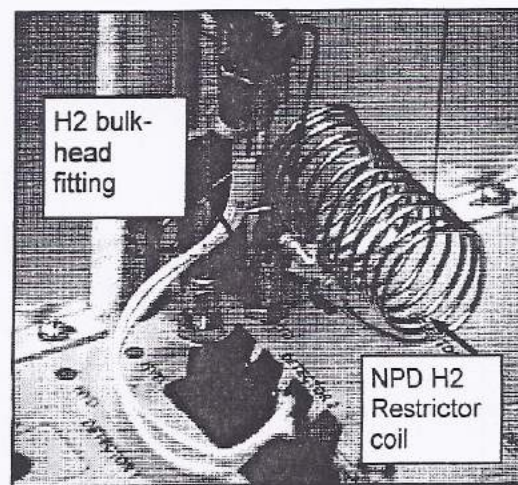

Chapter: Detectors

Topic: Converting from FID to NPD mode

To convert the FID detector to NPD detector:

4) The NPD bead plugs into the push terminal block on the GC directly beneath the detector. The terminals are labelled FID ignitor because this is where the FID ignitor is normally connected.

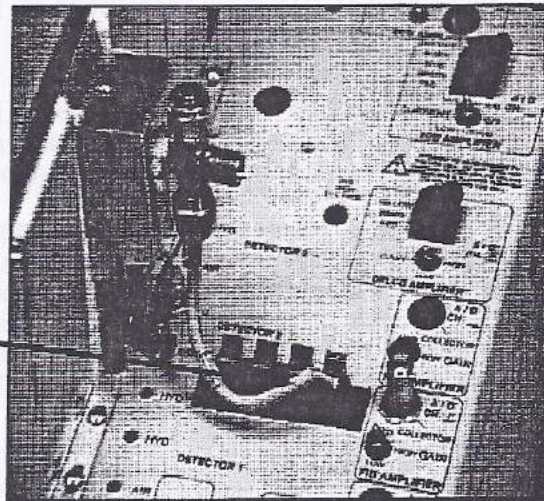

5) Because the NPD bead can only tolerate a maximum voltage of -4.50 volts, be careful not to set the FID volts setpoint higher than -4.50 . Be especially careful not to flip the FID ignite switch to the up position, as this will apply 10 volts to the NPD bead and burn it out. When an NPD detector is ordered separately from the FID, the NPD volts are automatically limited to -4.50 volts maximum. But when the FID and NPD share the bead/ignitor circuit, the operator must be careful not to apply more voltage than the bead can tolerate.

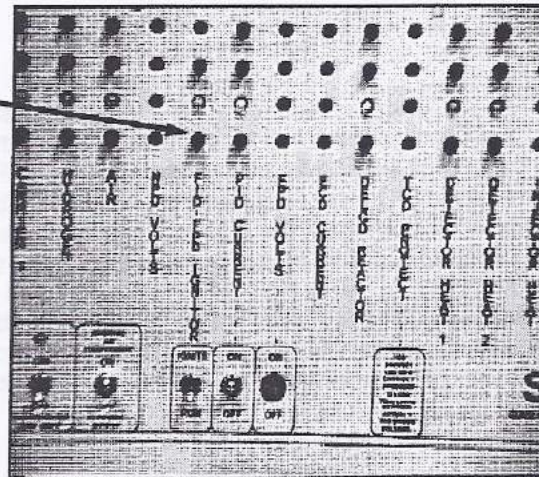

The Nitrogen / Phosphorus Detector, or NPD, as it is commonly referred to, is specified for the analysis of organic compounds containing nitrogen and/or phosphorus. The NPD detector is ideal for the analysis of pesticides and herbicides such as Parathion®, which contains nitrogen, phosphorus and sulfur. Minimum detectable quantities are in the 10 picogram range for this compound.

In principle, when organic compounds containing either nitrogen or phosphorus are introduced into a hydrogen plasma induced around a salt, charged particles or ions are generated, either by thermal ionization or oxidation. In the case of the NPD detector, ionization occurs as each sample component is eluted into the hydrogen plasma glowing around the NPD bead which is located directly at the exit of the analytical column. Ions freed in the plasma are then collected by a positively-charged collector electrode immediately adjacent to the gas plasma, and the electrical current produced by the passing of each component is carried to the electrometer/amplifier for processing and routing to the data system. The SRI NPD design exhibits extremely linear response.

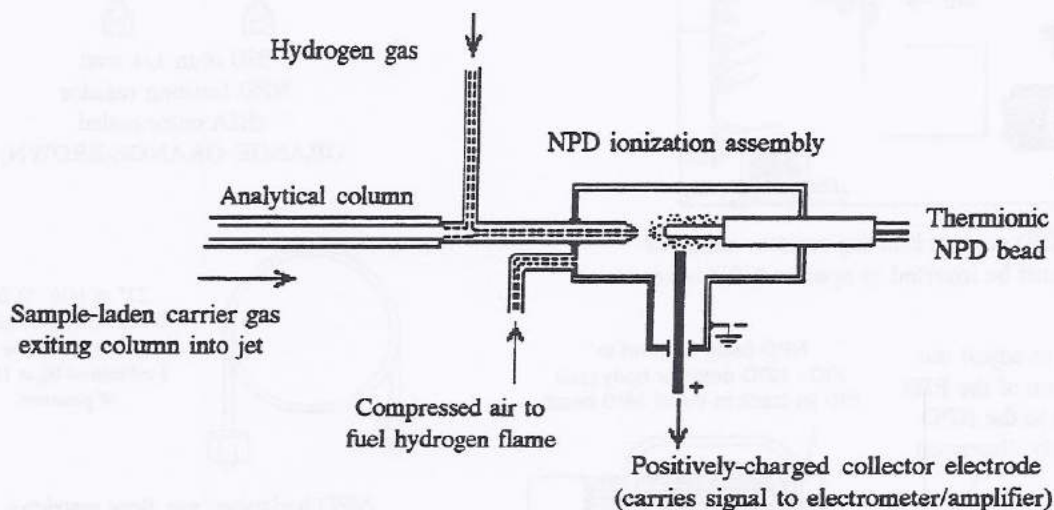

BASIC NITROGEN/PHOSPHORUS DETECTOR DIAGRAM

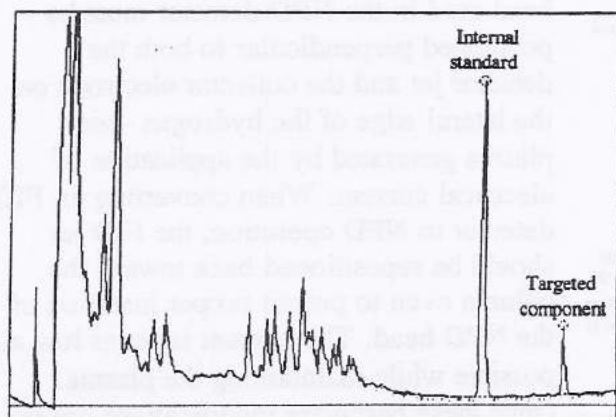

5 ppm concentration of target component in nitrogen

The illustration at left shows a 5ppm concentration of a proprietary gasoline additive in nitrogen. The operation of the NPD detector was adjusted to permit display of the gasoline peaks immediately preceding the internal standard and target peak. If the detector response was optimized, the selectivity of the detector would have eliminated the gasoline peaks from the chromatogram. In this case, it was desirable to show the gasoline peaks, and the NPD H₂ gas and bead were adjusted according.

The majority of gas chromatographs manufactured by SRI Instruments that offer the Nitrogen-Phosphorus Detector option are equipped with a flame ionization detector as standard equipment. The Nitrogen-Phosphorus Detector is configured for use by a conversion (hardware modification) to the FID system in the field. The modification of the FID detector is minimal and may be performed in a matter of minutes. Reversion back to the standard FID detector configuration may be performed as needed without any major interruption to the throughput of analyses through the chromatograph.

In some specific cases, the gas chromatograph is equipped with a permanent configuration of the nitrogen-phosphorus detector (NPD). On such models, the hardware modifications indicated on this page are not applicable, as the detector is already configured and not convertible.

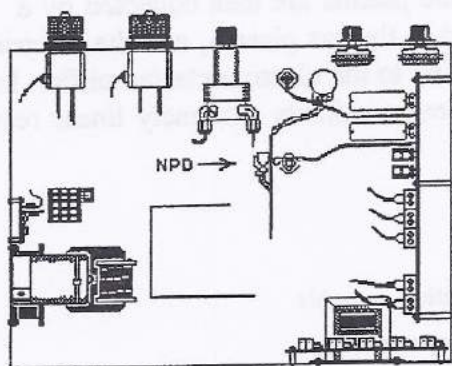

Location of NPD current limiting resistor inside of GC chassis (must be inserted to operate NPD bead).

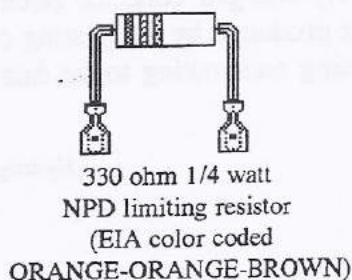

Loosen this nut to adjust the penetration position of the FID jet with relation to the NPD bead as previously illustrated

NPD bead inserted in FID - NPD detector body (pull FID jet back to insert NPD bead)

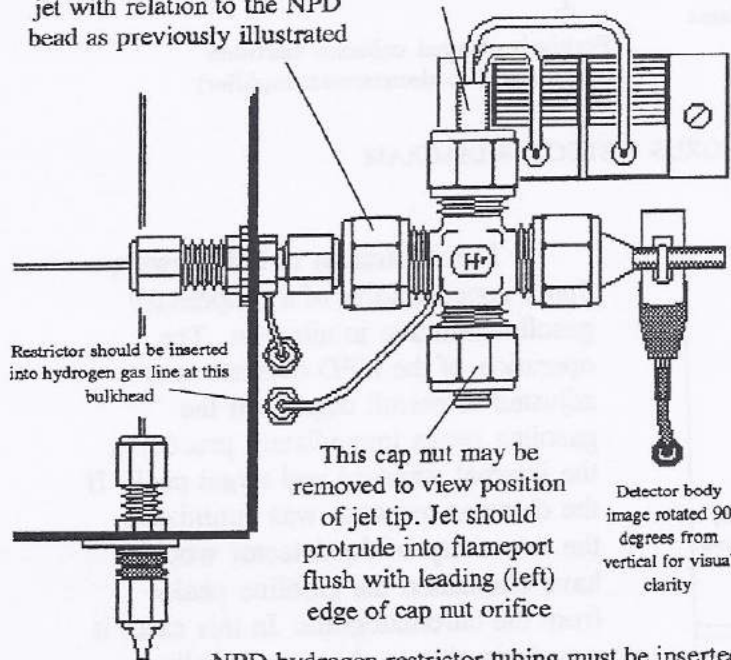

NPD hydrogen restrictor tubing must be inserted into hydrogen supply line to FID body to operate NPD detector

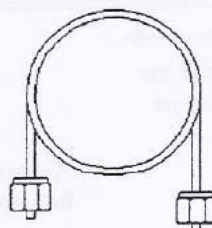

21" of 1/16" O.D.,
0.005" I.D. S.S. tubing
Flow should be
3 ml/min of H₂ at 10 psi
of pressure.

NPD hydrogen gas flow restrictor
(for reducing hydrogen gas flow
to proper level for NPD operation)

The thermionically-heated alkali bead used in the NPD detector must be positioned perpendicular to both the detector jet and the collector electrode on the lateral edge of the hydrogen - air plasma generated by the application of electrical current. When converting an FID detector to NPD operation, the FID jet should be repositioned back toward the column oven to permit proper insertion of the NPD bead. The current is set as low as possible while maintaining the plasma. Once these hardware modifications are in place as indicated, adjust the NPD detector as instructed on the previous page.

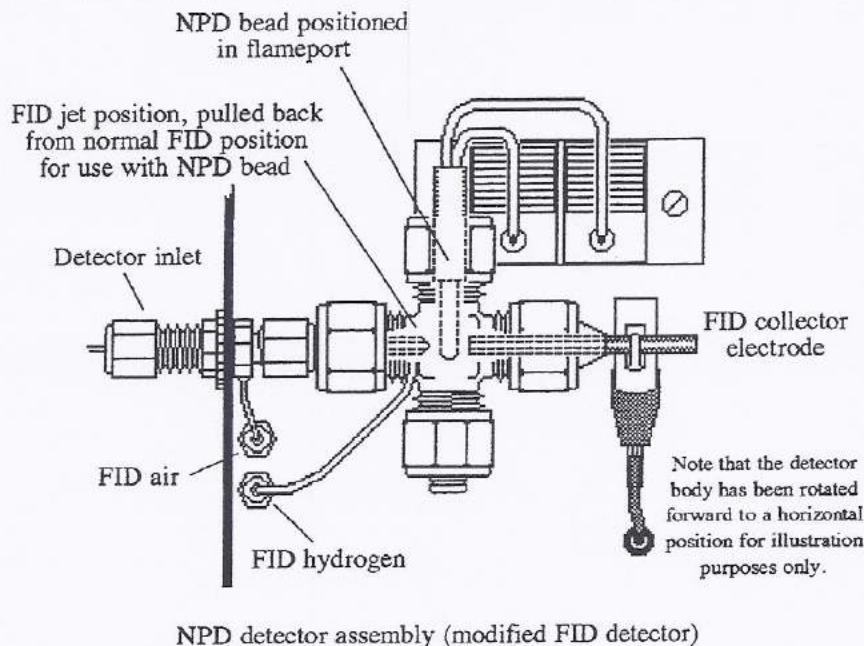

The SRI design FID detector converts quickly into a nitrogen - phosphorus detector by the simple replacement of the FID ignitor element with the electrically-heated thermionic NPD bead element. The hydrogen flow is then manually reduced to between 1 and 7 ml. per minute by the installation of a flow restrictor prior to the FID detector hydrogen bulkhead fitting (between 1 and 3 ml. per minute is optimum). With the heated NPD bead installed directly in the carrier gas flow exiting the FID jet orifice, the sample components are directed toward the area of the bead, where any molecule

containing a nitrogen or phosphorus group is prompted to release an electron in the hydrogen-air plasma generated by the bead. The liberated electron is attracted to the charged collector electrode and it creates a current that is delivered to the FID electrometer for processing. Note that the FID jet should be relocated (pulled away) from the NPD bead and collector electrode, as illustrated, for proper operation. Return the FID jet to its original position when returning to FID operation.

The nitrogen - phosphorus bead is extremely selective, providing 10,000 times higher response to nitrogen - phosphorus compounds than to hydrocarbons. When using the NPD detection method, nitrogen is the carrier gas of preference although helium carrier gas may be used. The bead must be operated with the minimum current required to maintain the hydrogen-air plasma. If more current than necessary is applied, the detector will show greater sensitivity, but the life and subsequent sensitivity of the NPD bead will be greatly reduced. The NPD should only be operated with the 330 ohm NPD current-limiting resistor in place in the circuit. AT NO TIME should the NPD voltage be operated above 4.4 volts. Nitrogen - phosphorus compounds increase the current in the plasma as they collide with the surface of the thermionic heated alkali metal bead.

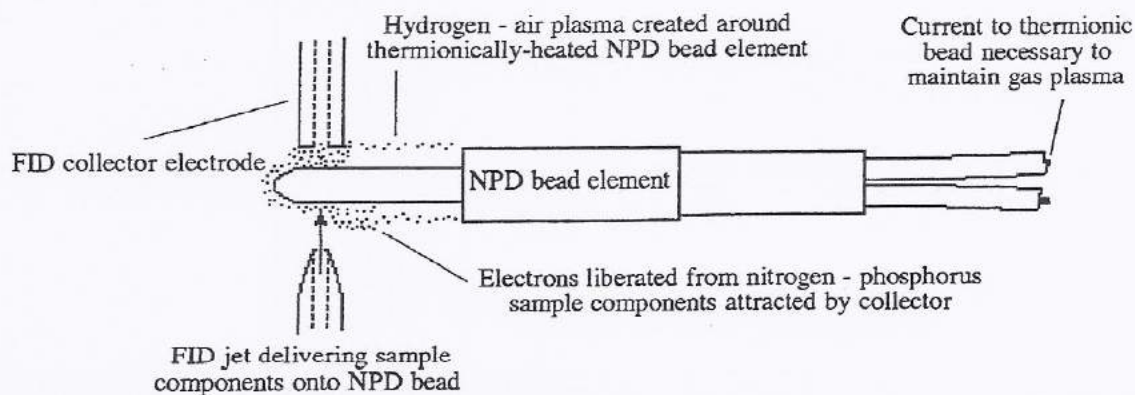

In order to operate the NPD detector, verify that the hydrogen flow rate is in the vicinity of 3 ml per minute by using a bubble flow meter capable of accurate measurement in that range. The hydrogen flow rate is normally maintained at 20 to 25 ml per minute. The air flow must be adjusted to approximately 80 ml per minute. This is much lower than the 250 - 300 ml per minute flow rate that is typically used for flame ionization detector operation.

Oxygenate Selective Detection for GC ETHANOL in GASOLINE

Negative ionization on a ceramic TID-1 surface detects Oxygenates with good selectivity vs. Hydrocarbons.

TID-1 detection provides a simple analysis for the Ethanol additive in gasoline. Only a single gas supply (Nitrogen) suffices for both GC carrier and detector gases. Short analysis times can be used because Ethanol is easily detected amidst many overlapping Hydrocarbon components. TID-1 also detects Phenols, Glycols, and other Oxygenated compounds.

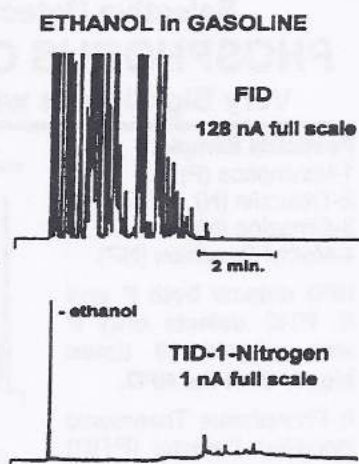

Oxygenate Selective Detection for GC CARBOXYLIC ACIDS

TID-1 surface ionization with an Air detector gas gives big signals for Carboxylic Acids relative to other Oxygenates like Alcohols. TID-1 detection includes Formic Acid which is not detected by an FID. TID-1 detection is also non-destructive so component aromas can be sensed at the detector exit. H₂O is also detectable to ppm levels

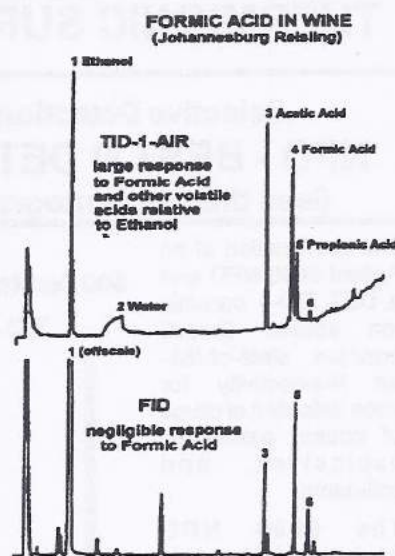

Selective Detection for GC TRIHALOMETHANES

TID-3 surface catalyzed negative ionization process

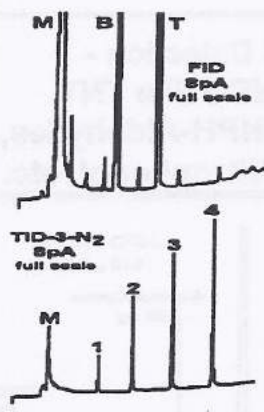

Volatile HALOGENATES detected with a sensitivity of 1 pg/sec, selectivity of 100,000:1 vs. hydrocarbons, and linear response exceeding a range of 10,000 in sample weight.

Unlike other halogen detectors, TID-3 response to Br is significantly more than Cl. Detector gas may be Nitrogen or Air with no requirement for ultra high purity. This detector is much easier and less costly to operate and maintain than an Electrolytic Conductivity Detector.

Sample analyzed:

640 pg each: 1=CHCl₃, 2=CHCl₂Br 3=CHClBr₂, 4=CHBr₃,
47,000 pg each: B=benzene T=toluene
2,500,000 pg: M=methanol Solvent: water

Pb - Sn - P - Si (Lead, Tin, Phosphorus, Silicon) selective detection with a DET innovation Organically-Fueled Remote FID

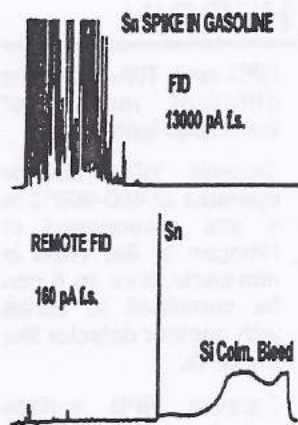

A polarizer and ion collector located several centimeters downstream of a flame jet detect long-lived ion species that originate in a flame fueled by H₂ - CH₄ - Air. Ionization from Hydrocarbon combustion at the jet dissipates before reaching the downstream collector.

Detectivity of 1 pg/sec for Pb, Sn, P with a selectivity of 500,000:1 versus Carbon.

Sample:
12 ppm tetraethyltin in gasoline

DETECTOR Engineering & Technology, inc.

486 North Wiget Lane, Walnut Creek, CA 94598 USA

ph: 925-937-4203, fx: 925-937-7581, www.det-gc.com

CHEMICAL DETECTION by DET

featuring novel applications of the principles of
THERMIONIC SURFACE IONIZATION and FLAME IONIZATION

Selective Detection for GC NPD - BEST N DETECTIVITY (less than 70 femtograms N/sec)

The combination of an Agilent 6890 NPD and a DET TID-4 ceramic ion source (bead) provides state-of-the-art N-selectivity for trace detection of drugs of abuse, pesticides, explosives, and pollutants.

The 6890 NPD hardware features a concentric cylinder ion source - collector electrode geometry for stream-lined gas flow and efficient ion collection. Similar DET equipment is available for HP5890, Varian 3400-3800, and SRI 8610 GC models.

600 femtograms Nicotine
TID-4 in 6890 NPD
2 pA f.s.

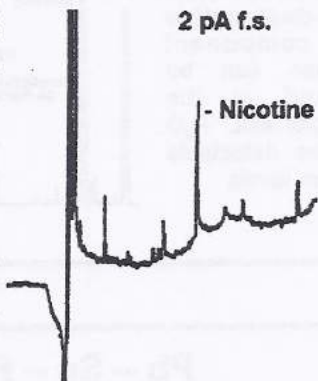

Selective Detection for GC PHOSPHORUS COMPOUNDS Very Big Signals with a New PTID

Pesticide Sample:

- 1-Mevinphos (P)
- 2-Trifluralin (N)
- 3-Simazine (N)
- 4-Methyl Parathion (NP)

NPD detects both P and N. PTID detects only P with signals 10 times bigger than the NPD.

A Phosphorus Thermionic Ionization Detector (PTID) combines surface ionization principles with high flows of Hydrogen and Air for P/C selectivity of 100,000:1, P/N selectivity of 100:1, detectivity of 70 fg P/sec, and a dynamic response range more than 100,000.

NP pesticides 480 pg each

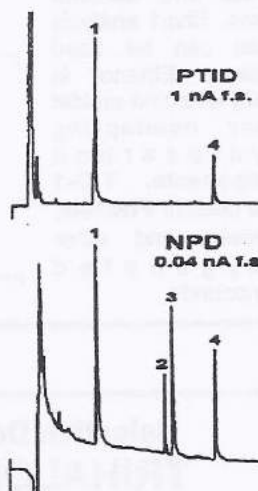

Tandem Thermionic Detection for GC COCAINE - HEROIN

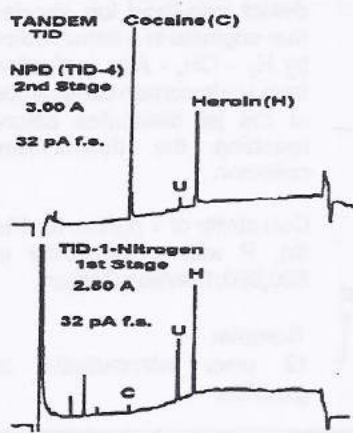

NPD and TID-1 are two different modes of thermionic ionization.

Ceramic TID-1 surface operates at 400-600°C in a gas environment of Nitrogen or Air. TID-1 is non-destructive so it can be combined in series with another detector like the NPD.

Ceramic NPD surface operates at 600-800°C in an ignited, dilute mix of Hydrogen in Air.

Sample analyzed: NPD detects both Cocaine (C) and Heroin (H). TID-1 detects Heroin and Heroin impurity (U). Tandem combination gives simultaneous TID-1 and NPD signals for each sample injection.

- Femtogram GC Detection - NITRO-COMPOUNDS like TNT, 2,4-Dinitrotoluene, DNPH-Aldehydes, Methyl Parathion, 4-Nitrophenol, etc.

Unique TID-1 surface ionization provides better selectivity than ECD and NPD, and needs only Air or N₂ as the detector gas with no requirement for high purity.

TID-1 detection is an inexpensive modification of Agilent 6890 NPD equipment. DET NPD/TID-1 equipment is also available to fit HP 5890, Varian 3400-3800, and SRI 8610 GC models.

EXPLOSIVES Sample: NPD has a big response to RDX and 4-Nitrotoluene. TID-1 has a much larger response to TNT.

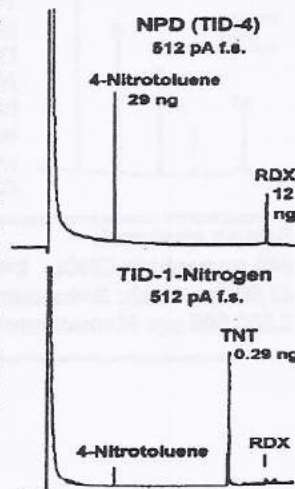

DETECTOR Engineering & Technology, inc.

□ **Invited Paper**

Recent Advances in Thermionic Ionization Detection for Gas Chromatography

P.L. Patterson

Detector Engineering & Technology, Inc., 2212 Brampton Road, Walnut Creek, California 94598

Abstract

Thermionic ionization detectors are most widely used for the specific detection of nitrogen-phosphorus compounds in gas chromatography. The operating mechanism of these detectors is a surface ionization process in which the key parameters are the work function of the thermionic emission surface, the temperature of the thermionic surface, and the composition of the gas environment in the immediate vicinity of the thermionic surface. By systematic variations of each of these three key parameters, the technique of thermionic ionization detection has been greatly expanded to encompass a number of different modes of response, all of which use similar detector hardware and electronic components.

process was operative, it was possible to identify three key operating parameters which control the ionization produced. These parameters are: the electronic work function of the thermionic emission surface which is determined by the chemical composition of the surface; the temperature of the thermionic surface; and the chemical composition of the gas environment immediately surrounding the thermionic surface.

The identification of these parameters has led to a clearer understanding of the complex chemistry active in NP detection, and has provided an important guide for expanding the applications of thermionic ionization techniques. Through systematic variations in each of the key parameters, many different modes of detector response have been achieved (3-6). Hence, the technique of thermionic ionization detection now correctly refers to a number of GC detector responses which are related through the use of many common hardware and electronic components. This article reviews the present state of development of the members of this unique group of detectors.

Introduction

Thermionic ionization detectors (TID) are best known in gas chromatography (GC) for their application to the specific detection of nitrogen (N) or phosphorus (P) compounds. All modern TIDs are essentially derivations of a basic design first described by Kolb and Bischoff (1) in 1974. The main component in this type of detector is an electrically-heated thermionic emission source in the form of a bead or cylinder which is usually composed of an alkali-metal compound impregnating a glass or ceramic matrix. In the TID, the thermionic source is positioned so that sample compounds may impinge upon its surface, and any ionization produced is measured by an adjacent collector electrode. Kolb and Bischoff were the first to report that a thermionic source comprised of a Rb-silicate glass bead produced very specific NP responses when the bead was operated at high temperatures in a gas environment of dilute H₂ in air.

Since the original work of Kolb and Bischoff, there have been continuing developments in NP detectors, with much emphasis on improved methods of construction and composition of the thermionic emission sources. The most important development, however, has been the recognition in recent years that the operation mechanism of a TID is a surface ionization process (2) rather than the gas phase ionization process originally proposed by Kolb et al. (1,3). Once it was clear that a surface ionization

Types of Thermionic Emission Sources

All commercially available TIDs use thermionic emission sources formed according to one of the following four general methods:

- (A) homogeneous alkali-glass bead formed on a loop of bare platinum wire (1);
- (B) alkali salt activator coated on a ceramic cylinder core containing an embedded heater coil (7);
- (C) homogeneous alkali-ceramic bead formed on a coil of nichrome heater wire (2,8,9);
- (D) multiple layers of cylindrically-shaped ceramic coatings, with a non-corrosive, electrically-conducting sub-layer of Ni-ceramic completely covering a loop of nichrome wire, and a surface layer comprised of alkali and/or other additives in a ceramic matrix (5,10).

Thermionic sources representing all four categories cited above have been used in NP detectors available from different manufacturers. Generally, those sources formed from ceramic materials provide greater flexibility for varying the chemical composition of the source. This is because the ceramic compositions are formulated and coated from a slurry at room temperature (9), whereas the glass compositions are formed in

a process that proceeds through a molten glass state (11).

The detailed chemical compositions of thermionic emission sources are usually regarded as confidential proprietary information by the manufacturer. Since the first alkali-glass bead reported by Kolb and Bischoff used Rb as the alkali compound, there existed for many years a belief that Rb was an essential component for optimum NP responses. However, in recent years, NP detectors with state-of-the-art performance specifications have been reported in which Cs rather than Rb is used as the alkali component (5). Also, another recent report (12) has described an NP detector which uses a $\text{LaB}_6/\text{SiO}_2$ bead and no alkali additive. In accordance with a mechanism of surface ionization prevailing in the TID, the most important characteristic of the thermionic emission surface is its electronic work function (i.e., the amount of energy required to emit a unit of electrical charge from the surface). Alkali-metal compounds have been especially successful additives because they lower the work function of the glass or ceramic matrix, thereby facilitating the emission of charged particles from the heated thermionic surface. The mathematical relationships between work function, surface temperature, and thermionic emission current have been discussed (2,12).

The development of multiple-layered, ceramic-coated thermionic emission sources has allowed examination of coatings of many different chemical compositions without the risk of materials in the surface layer corroding the heater wire. In the search for expanded applications for thermionic ionization techniques, the basic task is to define a specific match of a thermionic source type with an operating gas environment and a range of operating source temperatures. To date, three different chemical compositions of thermionic sources have been shown (5,6) to have useful applications in differing modes of thermionic detection. These source compositions are shown in Table I. Data obtained using these three types of thermionic emission sources are presented in the following sections.

Modes of Response

- Schematic illustrations of four different versions of thermionic ionization detection equipment are shown in Figures 1 through 4. Common components in each version are as follows:
- an electrically-heated, thermionic/catalytic source constructed of multiple layers of ceramic coatings;
 - a cylindrical collector electrode surrounding the cylindrically shaped thermionic source;
 - a source power supply that provides heating current to heat the source to typical temperatures of 400° to 800°C, and a bias voltage to polarize the source structure at a negative voltage with respect to the collector;

Table I. Thermionic Source Surface Layers

Source type*	Additive	Work function
TID-1	High concentration Cs	Low
TID-2	Low concentration Cs/Sr	Medium
CFID	Nickel	High

*Nomenclature adopted from Patterson (5).

(D) an electrometer that measures negative ionization currents arriving at the collector electrode.

The TID hardware usually mounts onto an FID-type detector base that is resident on a GC, so that two different detector gases may be supplied in addition to the GC effluent. Therefore, changes in the modes of detector response that correspond to the schematics of Figures 1 through 4 are accomplished by changes in the type of thermionic source, changes in the composition of gases supplied to the detector, or by changes in the operating temperature of the thermionic surface.

Most of the TIDs available commercially function by the collection of negative ionization rather than positive ionization. In the discussion that follows, it will be shown that the concepts of negative ion chemistry provide a logical pattern for correlating the responses of the different modes of thermionic detection.

TID-1-N₂: Nitro/electronegative specific response

The simplest mode of thermionic detection is represented by the schematic in Figure 1. In this mode, the low work function thermionic source designated by the TID-1 nomenclature is operated in a detector gas environment of N₂. Because the detector gases are inert, sample compounds interact directly with the TID-1 surface, which is typically heated to temperatures in the range of 400° to 600°C. The ionization process in this case is direct transfer of negative charge from the TID-1 surface to

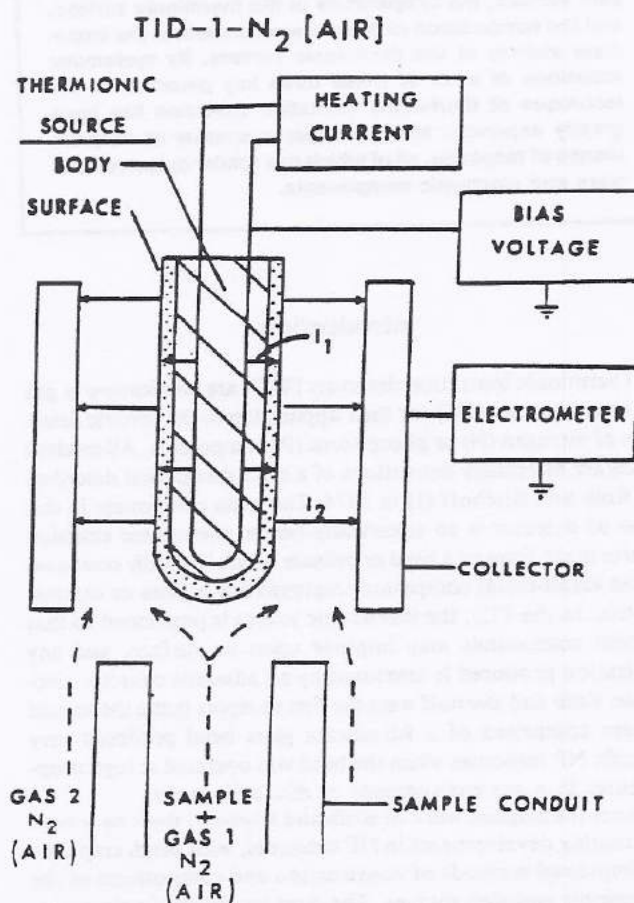

Figure 1. Schematic illustration of the detection configuration for the thermionic ionization modes TID-1-N₂ and TID-1-air. Detector gas 1=FID-H₂ inlet line; detector gas 2=FID-air inlet line.

the sample molecule. Consequently, this mode of response provides exceptionally high specificity and sensitivity to many compounds containing the nitro (NO_2) functional group (5,13), as well as to certain other electronegative compounds (e.g., pentachlorophenol, diazepam, and methaqualone). This mode of detection is very sensitive to the detailed electronegativity of the sample's molecular structure, as has been illustrated by the observation that a larger signal is obtained for the 2,4-isomer of dinitrotoluene in comparison to the 2,6-isomer (5). The TID-1- N_2 mode is superior to a conventional NP detector or an electron capture detector (ECD) for detection of trace level nitro-compounds such as nitro-PAH, nitro-explosives, nitro-pesticides (e.g., parathion, methyl parathion), nitro-drugs, nitro-derivatives. For many nitro-compounds, the specificity vs. hydrocarbons is an astonishing 10^8 , and detectivity is in the 0.1- to 1.0-pg range (5).

TID-1-air: Halogen/nitro specific response

When the TID-1 thermionic source is operated in an oxygen-containing gas environment rather than one of N_2 , specific responses to halogenated compounds are enhanced while responses to nitro-compounds are decreased somewhat (14). The TID-1-air mode of detection is generally not as sensitive as an ECD or Hall detector for chlorinated compounds, but it provides halogen specificity at higher concentrations where ECD and Hall are saturated. Typical specificity is 10^6 and detectivity

is 0.1 to 1.0 ng. This is an especially simple mode of detection for ethylene dibromide (EDB) in the headspace vapors of food products.

TID-2- H_2 /air: Nitrogen/phosphorus specific response

The schematic illustration of Figure 2 represents the situation that prevails in an NP detection mode. For this mode, H_2 and air gases are supplied to the detector, and a thermionic source of moderate work function (i.e., TID-2) is operated hot enough (600° to 800°C) to cause thermal/chemical decomposition of the H_2 and O_2 gases. A critical parameter in this NP mode is the restriction of the H_2 to low flows (e.g., 3 to 6 ml/min) which are not sufficient to maintain a self-sustaining flame at the sample conduit (i.e., jet structure) depicted in Figure 2. Instead, a flame-like gaseous boundary layer is created in the immediate vicinity of the hot thermionic source. Since this boundary layer is very reactive chemically, sample compounds are decomposed by the active gas phase chemistry, and electronegative products of decomposition are selectively ionized by surface ionization on the thermionic source. N or P compounds are ionized with especially high specificity by this process. An essential condition for the onset of NP detection is that the thermionic source must be hot enough to "ignite" the boundary layer chemistry. Under these conditions, a thermionic source of moderate work function provides the optimum compromise of sample response signal vs. detector background signal. A low work function therm-

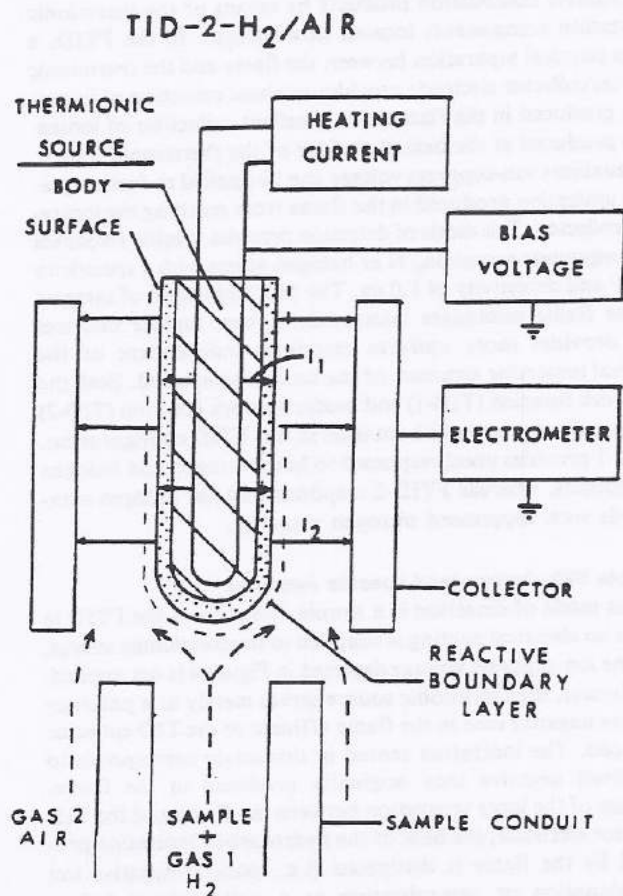

Figure 2. Schematic illustration of the detection configuration for the TID-2- H_2 /air or NP mode of thermionic ionization.

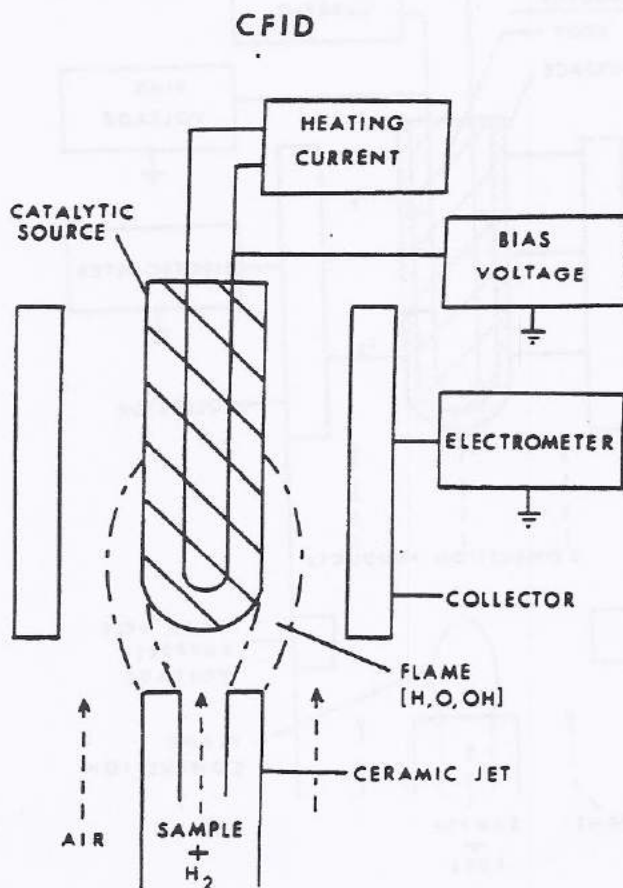

Figure 3. Schematic illustration of the detection configuration for the catalytic flame ionization detector (CFID) mode of response.

ionic source (e.g., TID-1) operated under these conditions would produce an overwhelmingly large background signal. Conversely, a high work function thermionic source (e.g., catalytic flame ionization detection) operated under these conditions would produce smaller NP signals and less specificity than the moderate work function thermionic source. Typical performance specifications for NP detectors are detectivities in the range of 1 to 10 pg, and specificity with respect to hydrocarbons in the range of 10^4 to 10^5 .

CFID: Universal response to all organics

Figure 3 depicts a mode of response achieved when the H_2 flow to the detector is sufficient to produce a true self-sustaining flame burning at the jet structure. This mode of operation has been designated (5) catalytic flame ionization detection (CFID) because of its close similarity to a conventional FID. The CFID is essentially an FID which has been modified by inserting an electrically-heated catalytic source comprised of a Ni-impregnated ceramic into the center of the active flame region. In this detection mode, the catalytic source structure serves the three-fold function of flame ignitor, flame polarizer, and catalytic combustion modifier/thermionic surface ionizer. In the CFID, two types of ionization processes are active: gas phase ioniza-

tion processes identical to those which occur in a conventional FID, and surface ionization processes at the catalytic source structure which especially enhance the ionization efficiency of many heteroatom compounds (especially halogenated and phosphorus compounds).

Like a conventional FID, the magnitude of the gas phase ionization is determined primarily by the magnitudes of H_2 and air flows and the size of the jet orifice, so that additional electrical heating of the CFID source has little effect on the gas phase ionization. However, the magnitudes of ionization produced by surface processes at the CFID source is strongly dependent on the electrical heating of the source. Hence, in many cases, response factors for heteroatom compounds can be enhanced to be comparable to hydrocarbons by a judicious selection of source heating current. For this CFID mode of detection, the thermionic/catalytic source of highest work function is most suitable because the flame heat would otherwise cause an excessive thermionic emission background signal. The CFID provides detectivities in the 10- to 100-pg range for most organic compounds.

FTID: Nitrogen/halogen specific response

Figure 4 depicts a further detection mode in which the thermionic source and collector electrode structure are positioned well downstream of the active region of a self-sustaining flame. The basic concept (6) of this flame thermionic ionization detection (FTID) mode is to burn sample compounds in a self-sustaining H_2 /air flame at a flame jet, and to selectively re-ionize electronegative combustion products by means of the thermionic ionization components located downstream. In the FTID, a large physical separation between the flame and the thermionic source/collector electrode provides minimal collection of ionization produced in the flame, but excellent collection of ionization produced at the heated surface of the thermionic source. An auxiliary ion-suppress voltage can be applied to further prevent ionization produced in the flame from reaching the ionization collector. This mode of detection provides specific responses to compounds containing N or halogen atoms with a specificity of 10^3 and detectivity of 1.0 ng. The precombustion of samples in the flame minimizes interferences from sample matrices and provides more uniform responses independent of the original molecular structure of the sample compound. Both the low work function (TID-1) and moderate work function (TID-2) thermionic sources have been used in this FTID configuration. FTID-1 provides good responses to both nitrogen and halogen compounds, whereas FTID-2 responds best for halogen compounds with suppressed nitrogen response.

Remote FID: Organo-lead specific response

This mode of detection is a simple variation of the FTID in which no electrical heating is supplied to the thermionic source, and the ion-suppress voltage depicted in Figure 4 is not applied. In this case, the thermionic source serves merely as a polarizer to drive negative ions in the flame effluent to the TID collector electrode. The ionization sensed in this mode corresponds to long-lived negative ions originally produced in the flame. Because of the large separation between the flame and the TID collector electrode, the bulk of the hydrocarbon ionization produced by the flame is dissipated (i.e., positive-negative ion recombination or neutralization at a wall surface) before reaching the TID collector. However, certain heteroatom compounds appear to combust to negative ion products which are especially stable and long-lived. The outstanding demonstration

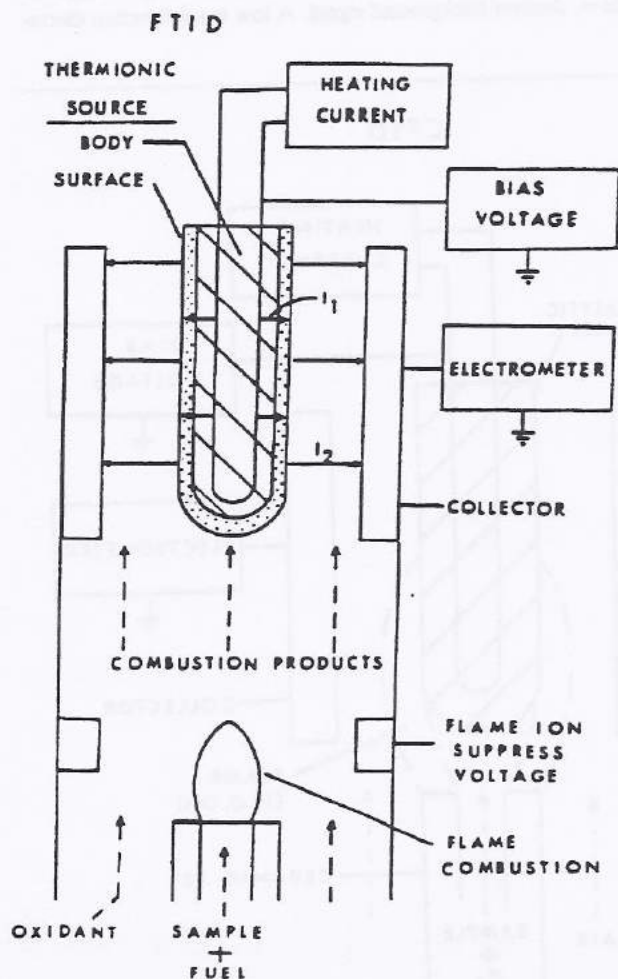

Figure 4. Schematic illustration of the detection configuration for the flame thermionic ionization detector (FTID) mode of response.

of this effect is the specific detection of lead compounds in gasoline. Since the thermionic source is not electrically-heated and is not used as a source of surface ionization, any type of thermionic source may be employed in this mode.

Experimental

The applications data presented in this report were obtained with equipment previously described (5,6,14). All the data were obtained using a Model 3740 gas chromatograph (Varian Associates) equipped with either a TID/CFID detector assembly (TID-1-N₂, TID-1-air, TID-2-H₂/air, and CFID modes) or an FTID/TID detector assembly (FTID and remote FID modes) (Detector Engineering and Technology). The TID-1, TID-2, and CFID thermionic emission sources were also manufactured by Detector Engineering and Technology, as was the Model 4000 detector current supply. Negative ionization signals from the detector were measured using the differential electrometer (Varian) in a negative polarity configuration.

The detector assemblies mounted onto the FID-base on the GC, so that different detector gas environments were implemented by plumbing in the appropriate gas through the two gas lines that normally supply H₂ and air to an FID. Typical gas flows supplied for different modes of detection are detailed in Table II.

All the data presented in this report were obtained using glass columns, 6 ft × 1/4 in. × 2 mm i.d., packed with either 3% SP-2250, 3% SP-2100, or 1% SP-1240 DA on 100/120 Supelport (Supelco) or 80/100 Chromosorb 102. The GC carrier gas in all cases was N₂ at a flow rate of 30 ml/min. For complex samples like gasoline, the chromatographic separation was intentionally very poor in order to produce a challenging detector environment to demonstrate specificity of response in the simultaneous presence of many overlapping compounds.

Sample mixtures that were analyzed included a TSD test sample (ng levels of azobenzene, methyl parathion, and malathion) (Varian); Base-Neutral 1 sample (Supelco); phenol mix (Supelco); DCMA PCB mixture (Supelco); and nitroaromatic mixture (Supelco) diluted in reagent-grade benzene. Gasoline, cologne, and diesel fuel samples were analyzed by direct injection of 0.5 to 1.0 μl amounts onto the column. Other samples chromatographed were a 1% v/v each mixture of acetone and carbon tetrachloride in water; and an 11% v/v each mixture of methylene chloride, n-C₄, benzene, i-C₅, toluene, n-C₁, p-Xylene, n-C₁₀, and n-C₁₂.

Table II. Typical Gas Flows Supplied for Each Mode of Detection

Mode	Gas 1	Gas 2
TID-1-N ₂	10 ml/min N ₂	60 ml/min N ₂
TID-1-air	10 ml/min air	60 ml/min air
TID-2-H ₂ /air	3 ml/min H ₂	60 ml/min air
CFID	25 ml/min H ₂	200 ml/min air
FTID	20 ml/min H ₂	200 ml/min air
Remote FID	20 ml/min H ₂	200 ml/min air

Applications*

Specially formulated test samples are often employed to demonstrate the specificity and sensitivity of NP detectors. The data in Figure 5 correspond to such a test sample comprised of 2.2 ng each of azobenzene (N) and methyl parathion (N,P), 4.4 ng of malathion (P), and 4400 ng of n-C₁₁ in a solvent of iso-octane. The data illustrate clearly the substantial differences in response between two different modes of thermionic detection, and the very high specificity of the TID-1-N₂ mode for sensing the NO₂ group in methyl parathion. The ionization signals in both chromatograms are very large, indicating detectivities in the pg and sub-pg range.

Figure 6 shows another comparison of the TID-1-N₂ mode vs. the NP mode of detection for a sample consisting of 15 pg amounts of the 2,4- and 2,6-isomers of dinitrotoluene in a relatively impure, reagent grade benzene solvent. For many nitro-compounds, the TID-1-N₂ mode provides substantial improvements in specificity and sensitivity in comparison to an NP mode. However, the NP mode (i.e., TID-2-H₂/air) provides more universal detection for all N-compounds. In Figure 6, the differing magnitudes of TID-1-N₂ signals for the two dinitrotoluene isomers also demonstrate that the TID-1-N₂ signals are very sensitive to the detailed electronegative character of the sample's molecular structure.

Figure 7 shows the differing responses of six modes of thermionic detection in the analysis of base neutral compounds of concern as water pollutants. The CFID provides universal response to all compounds in this sample with a relatively uniform sensitivity of 0.01 coul/gC. The TID-1-N₂ mode of opera-

*Data presented are from References 6 and 14.

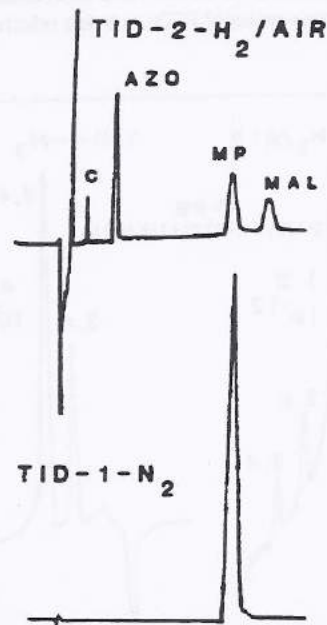

Figure 5. Chromatograms showing two modes of response to a test sample containing a large concentration of a hydrocarbon (C) and trace levels of azobenzene (AZO), methyl parathion (MP), and malathion (MAL). Both chromatograms were recorded at the same sensitivity of 128×10^{-11} amps/mV. Column: SP-2250, isothermal at 210°C.

tion provides very specific responses only to a nitro-compound (2,6-dinitrotoluene) and a chlorinated compound (3,3'-dichlorobenzidene). The lack of significant TID-1-N₂ response to nitrobenzene, bis(2-chloroethyl)ether, bis(2-chloroisopropyl)ether, or 4-bromophenyl-phenyl-ether demonstrates that the TID-1-N₂ response depends on how the electronegative functionalities are bound up in the molecular structure of the sample compound. When the detector gas environment of the TID-1 source is changed from N₂ to O₂, the TID-1-O₂ mode provides enhanced relative responses to the chlorinated compounds and a diminished relative response to the nitro-compound. The TID-1-O₂ mode continues to provide good discrimination in favor of chlorinated compounds with respect to hydrocarbons, while exhibiting some low level responses to phthalate compounds. The TID-2-H₂/air mode responds to all the N-compounds, with some small interferences from chlorinated compounds. The FTID-1 mode uses a TID-1 source and provides responses to all the nitrogen and halogen compounds in the sample. The FTID-2 mode uses a TID-2 source which produces responses to the halogenated compounds but suppressed responses to nitrogen compounds in comparison to FTID-1. This set of six chromatograms provides a good illustration of how the detector response can be varied through simple changes in the composition of the detector gas environment.

Figure 8 shows chromatograms of a sample mixture consisting of 75 ng each of 2-chlorophenol, 2-nitrophenol, phenol, 2,4-dimethylphenol, and 2,4-dichlorophenol; 225 ng each of 2,4,6-trichlorophenol, and 2,4-dinitrophenol; and 375 ng each of 4-chloro-*m*-cresol, 4,6-dinitro-*o*-cresol, pentachlorophenol, and 4-nitrophenol. The CFID provides a relatively uniform response of 0.004 coul/gC for all these compounds. (Note: The flame tip orifice for these CFID data was 0.062 in. instead of 0.031 in., which is normally used. The smaller orifice usually provides improved sensitivities of approximately 0.01 coul/gC.)

The CFID data provide a good illustration of a principal difference in the responses of a CFID vs. a conventional FID. It is well known that conventional FIDs provide relatively uniform

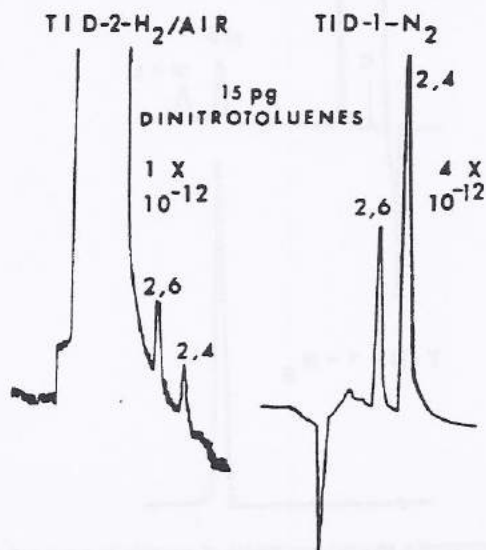

Figure 6. Chromatograms comparing the responses of the TID-1-N₂ mode and the TID-2-H₂/air (NP) mode to traces of dinitrotoluenes. Column: SP-2100, 160° to 200°C at 10°/min.

response to many hydrocarbon compounds. However, when heteroatoms, such as O, Cl, or P, are present in the sample compounds, the FID response is frequently significantly lower than its response to hydrocarbons. In contrast, the CFID appears to yield more uniform response to all organic compounds ir-

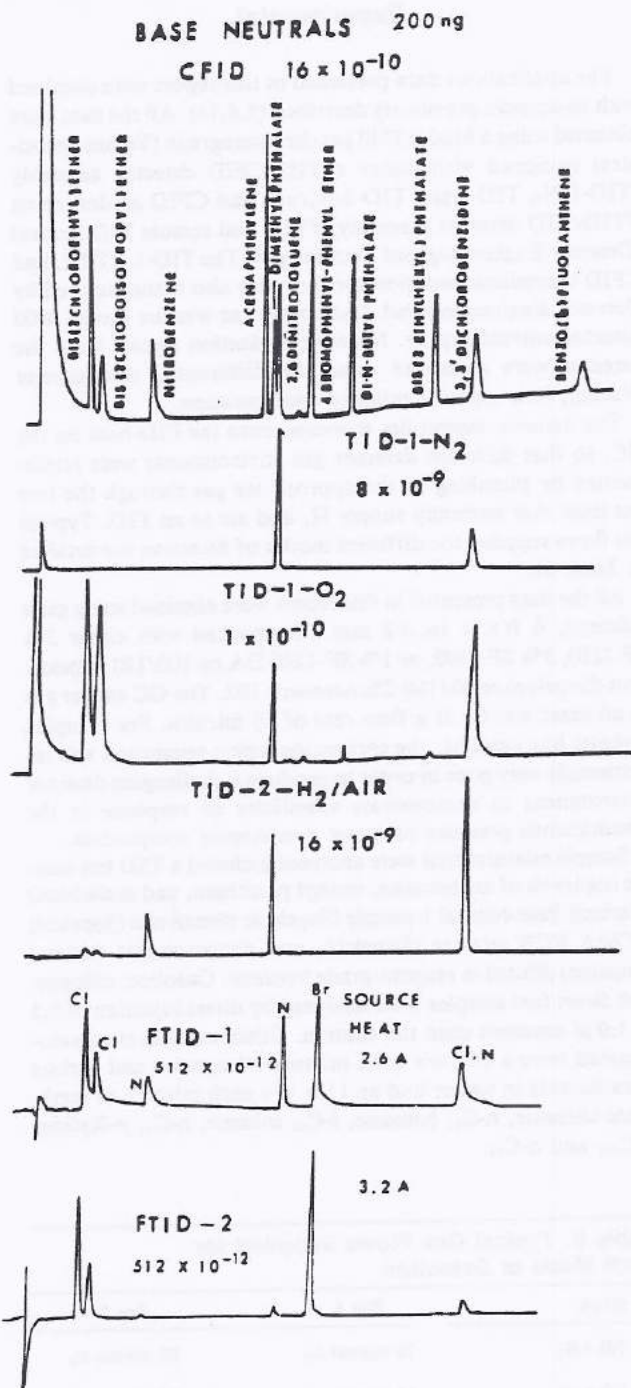

Figure 7. Chromatograms showing six different modes of detector response to a sample of base neutral compounds. In increasing order of retention time, the components of the sample are bis(2-chloroethyl)ether; bis(2-chloroisopropyl)ether; nitrobenzene; acenaphthylene; dimethylphthalate; 2,6-dinitrotoluene; 4-bromophenyl-phenyl ether; di-*n*-butylphthalate; bis(2-ethylhexyl)phthalate; 3,3'-dichlorobenzidine; and benzo(*b*)fluoranthene. Column: SP-2250; 100°C, held for 4 min, then 100° to 270°C at 16°/min.

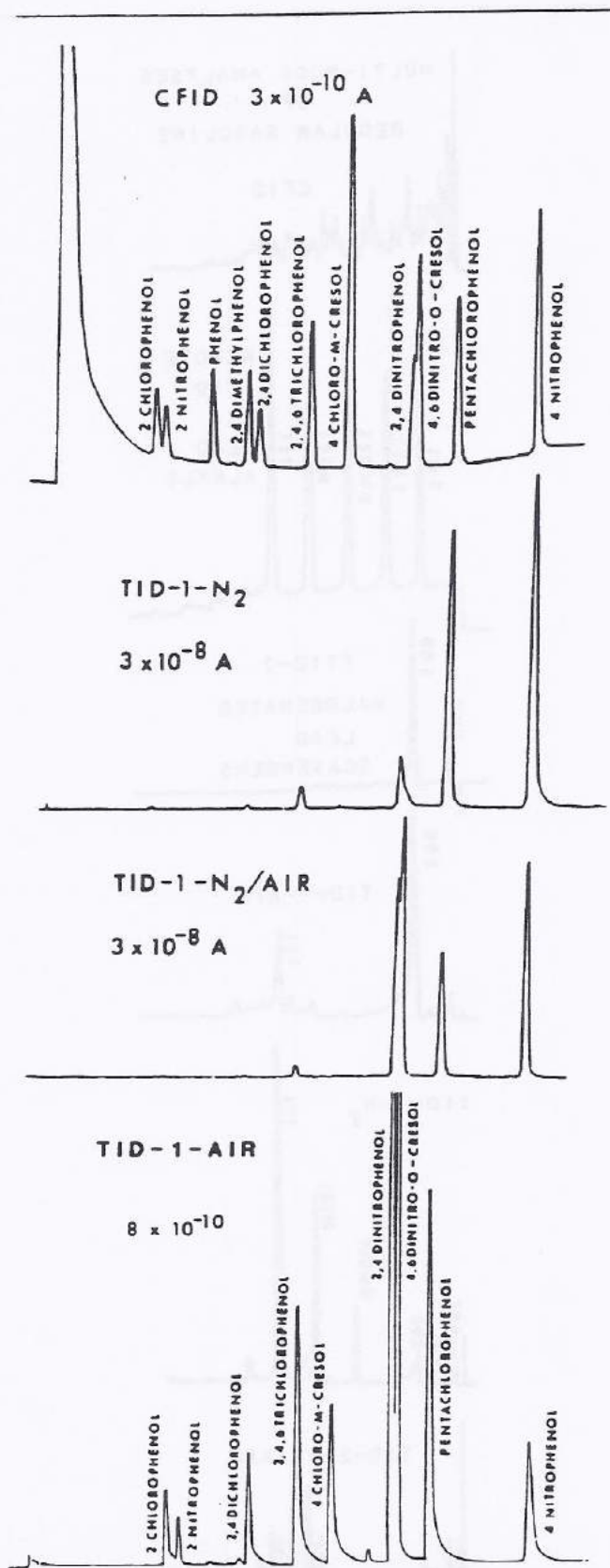

Figure 8. Chromatograms showing different modes of detector response to phenol sample containing 2-chlorophenol; 2-nitrophenol; phenol; 2,4-dimethylphenol; 2,4-dichlorophenol; 2,4,6-trichlorophenol; 4-chloro-*m*-cresol; 2,4-dinitrophenol; 4,6-dinitro-*o*-cresol; pentachlorophenol; and 4-nitrophenol in order of increasing retention time. Column: SP-1240, 100° to 210°C at 8%/min.

respective of whether they are hydrocarbon or heteroatom compounds. This is the result of the additional ionization process that occurs at the surface of the catalytic CFID source.

As anticipated, the TID-1-N₂ mode in Figure 8 provides high specificity and sensitivity to certain nitro- and polychlorinated-phenols. The responses to pentachlorophenol and 4-nitrophenol are more than 100 times larger than the CFID responses to these compounds. Comparing the responses of 4-nitrophenol and 2-nitrophenol again illustrates a significantly greater TID-1-N₂ response for the isomer with the nitro group located at the 4-position in the molecule.

In the third chromatogram in Figure 8, the low work function thermionic source (TID-1) was operated in a detector gas environment comprised of approximately equal flows of N₂ and air. This illustrates that the composition of the gas environment is an additional parameter which can be used to suppress the response to certain compounds while enhancing the response to others.

The bottom chromatogram in Figure 8 shows the analysis of the phenol sample for the case where both detector gases 1 and 2 are air. Responses are now obtained for all the chlorinated and nitro-phenols, with the dinitro-compounds continuing to give the dominant responses. The responses to 2-nitrophenol and 4-nitrophenol are now comparable, in contrast to the TID-1-N₂ response in which there was significant preference for the nitro group in the 4-location vs. the 2-location.

Figure 9 demonstrates the high specificity for lead alkyls in

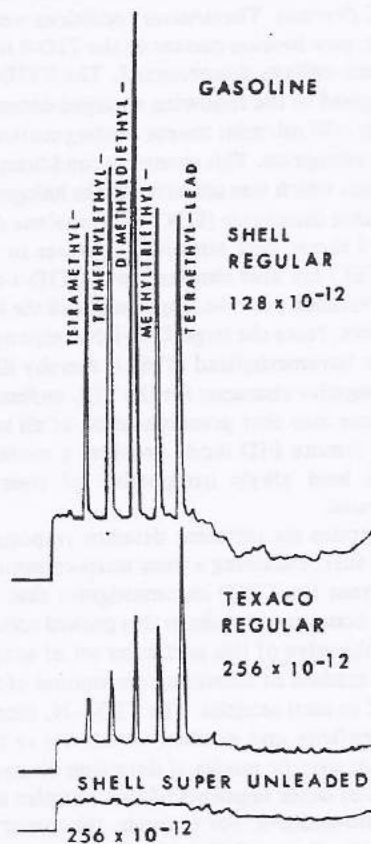

Figure 9. Chromatograms illustrating the specific detection of lead alkyls in gasoline using the remote FID. Data correspond to samples randomly obtained from local gasoline stations. Column: SP-2100, 50° to 230°C at 15%/min.

gasoline provided by the remote FID mode of detection. Previously, GC/atomic absorption spectroscopy (AAS) instrumentation has been described for the specific detection of lead alkyls in gasoline or other samples (15). By comparison with AAS, the remote FID provides excellent sensitivity and specificity, and is considerably simpler and less expensive to operate. The data shown in Figure 9 were obtained by direct injections of 0.8- μ l amounts of the gasolines onto a temperature-programmed, packed column.

The remote FID mode of detection has some configuration similarities to a hydrogen atmosphere flame ionization detector (HAFID), which has also been reported to provide specific detection of lead alkyls in gasoline (16). Both the remote FID and HAFID use a collector electrode well removed from the flame jet structure. However, the signals in the remote FID are largest with an oxygen-rich flame, whereas the HAFID requires a hydrogen-rich atmosphere doped with silane.

Gasoline is a readily available, complex mixture of organic compounds which is especially well suited to demonstrating the different responses obtained in the family of thermionic detection modes. Figure 10 shows multiple modes of analysis of a sample of regular gasoline. The chromatographic separation was performed on a packed column to purposely create the demanding situation in which many overlapping compounds are present in the detector volume at the same time. This situation is shown to be the case by the CFID response. When the same gasoline sample is chromatographed using the remote FID mode, selective responses are obtained only for the five lead alkyls. The remote FID data in Figure 10 were obtained with an FTID detector assembly and a TID-2 source mounted on a Model 3700 GC (Varian). The detector conditions were $H_2 = 30$, air = 200 ml/min; zero heating current to the TID-2 source; and flame ion-suppress voltage disconnected. The FTID-2 data in Figure 10 correspond to the following changed detector conditions; $H_2 = 30$, air = 80 ml/min; source heating current = 3.2 A; and ion-suppress voltage on. This change in conditions produced an FTID-2 response which was selective for the halogenated lead scavengers, ethylene dichloride (EDC) and ethylene dibromide (EDB). Figure 10 shows that selective responses to EDB and tetraethyllead (TEL) are also obtained in the TID-1-air mode, while the TID-1-N₂ mode provides responses to all the lead alkyls and lead scavengers. Note the large TID-1-N₂ response to TEL in comparison to tetramethyllead (TML), thereby illustrating a greater electronegative character for the TEL molecular structure vs. TML. Note also that precombustion of all samples in the flame of the remote FID mode provides a more uniform response for all lead alkyls irrespective of their original molecular structures.

Figure 11 illustrates six different detector responses in the analysis of diesel fuel containing a trace nitro-compound additive. It is clear from the CFID chromatogram that there are many unresolved component peaks in this packed column analysis. A primary objective of this particular set of analyses was to define the best method of measuring the amount of the nitro-compound added to such samples. The TID-1-N₂ mode clearly gives the best specificity and excellent sensitivity to the nitro-additive. The other specific modes of detection illustrate selective enhancement of other segments of this complex sample in addition to the nitro-additive. For example, the cluster of peaks at late retention times in the TID-2-H₂/air chromatogram undoubtedly corresponds to other N-compounds in the sample. The two FTID-1 chromatograms illustrate that the H₂-air mixture ratio is a further means of significantly altering the FTID re-

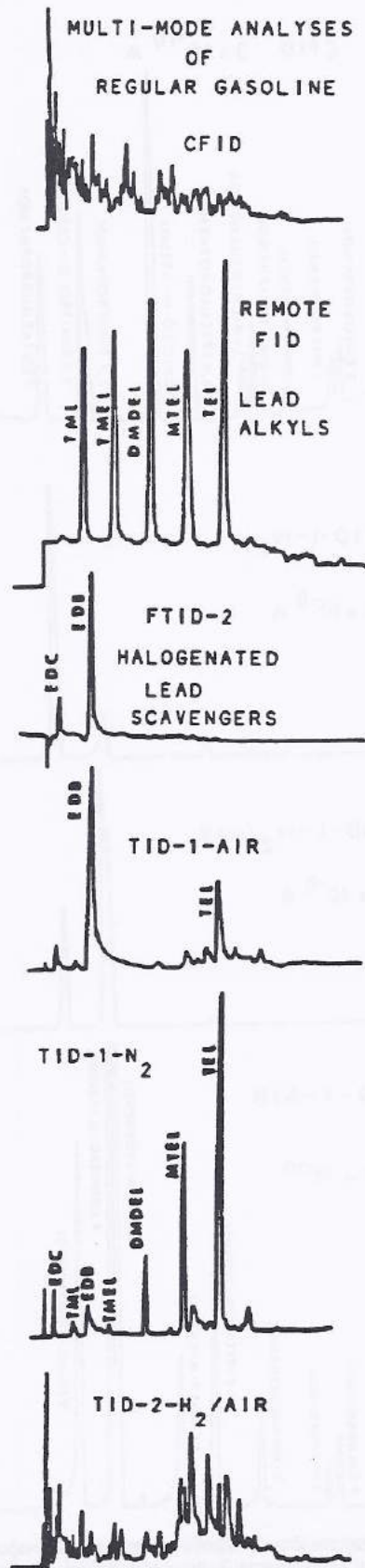

Figure 10. Chromatograms showing multiple modes of detector response to a sample of regular leaded gasoline. Column and program same as in Figure 9.

sponse. The mixture of 20 ml/min H₂, 100 ml/min air represents an oxygen-rich flame, while the mixture of 35 ml/min H₂, 70 ml/min air is a hydrogen-rich flame. Generally, stoichiometric or oxygen-rich flames are the most useful for the FTID.

Figure 12 shows multiple mode analyses of a commercial brand of cologne. These sets of chromatograms illustrate the advantageous use of the specific detection modes to enhance responses for trace fragrance components in colognes. The TID-1-N₂ mode is especially useful because it is non-destructive. Therefore, TID-1-N₂ emits exhaust gases that are characterized

by distinctly different fragrances that change with time as the various segments of the chromatogram elute. For the cologne shown, as well as for other brands that have been examined, the set of chromatograms obtained from the different modes of thermionic detection provide a characteristic fingerprint that distinguishes one brand from another.

All the modes of detection described in this article measure negative ionization currents. The magnitudes of these currents are very dependent on the electronegative character of the chemical species adjacent to the heated thermionic source.

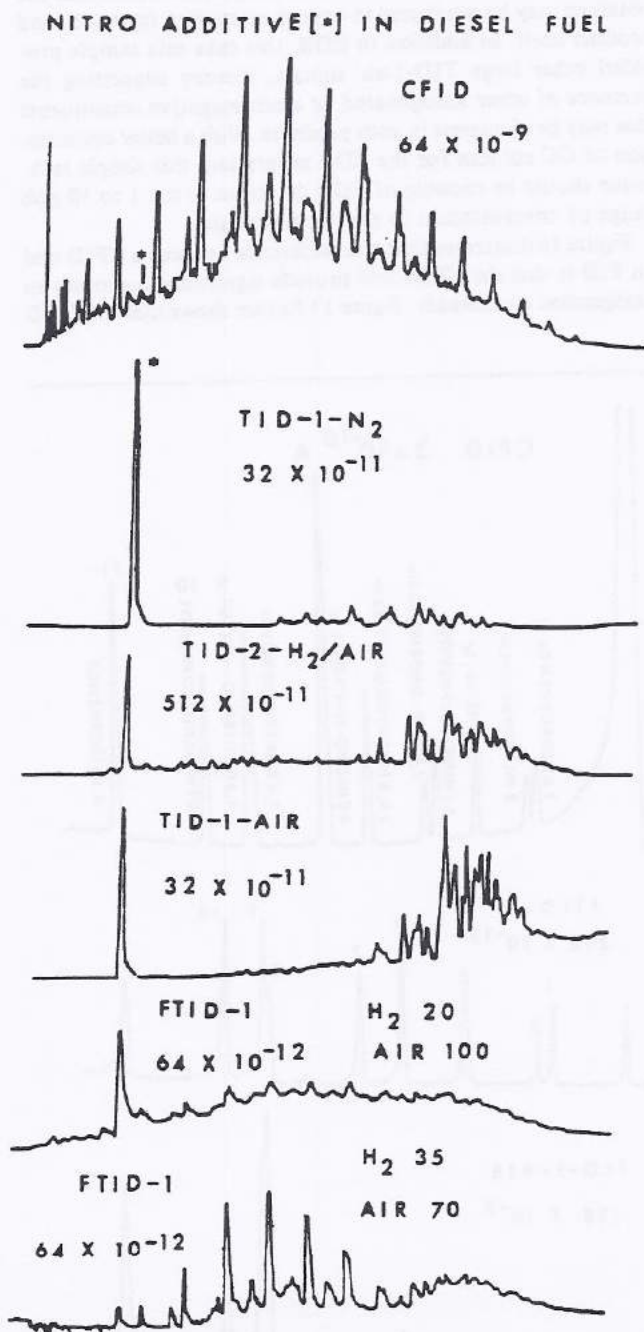

Figure 11. Chromatograms showing different detector responses to a sample of diesel fuel containing a trace nitro-compound additive identified by the asterisk. Column SP-2100, 90° to 270°C at 10°/min.

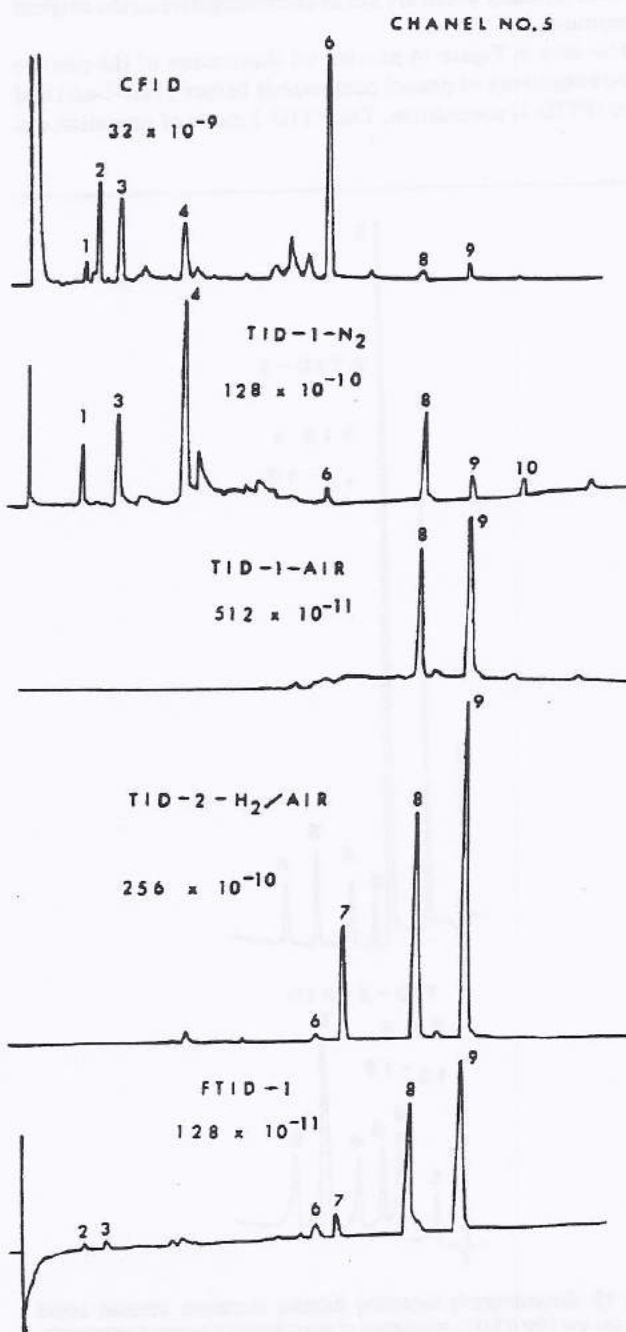

Figure 12. Chromatograms showing multiple modes of detector response to a brand of cologne randomly obtained. Column: SP-2100, 100° to 270°C at 16°/min.

Figure 13 illustrates how the response to a group of polychlorinated biphenyl (PCB) compounds changes with precombustion of the compounds. The data obtained with a TID-2 source in an air environment exhibit large differences in response between the different PCB compounds, similar to the known characteristics of an ECD. The FTID-2 data show that the precombustion of the PCBs yield negative ionization currents, which are larger in magnitude as well as more uniform per Cl atom. In this case of PCBs, precombustion improves the detectability by producing chemical species more electronegative than the original compounds. For other compound types, precombustion sometimes causes the opposite effect of producing combustion products which are not as electronegative as the original compound.

The data in Figure 14 provide an illustration of the relative electronegativity of phenol compounds before (TID-1-air) and after (FTID-1) combustion. The FTID-1 mode of operation can

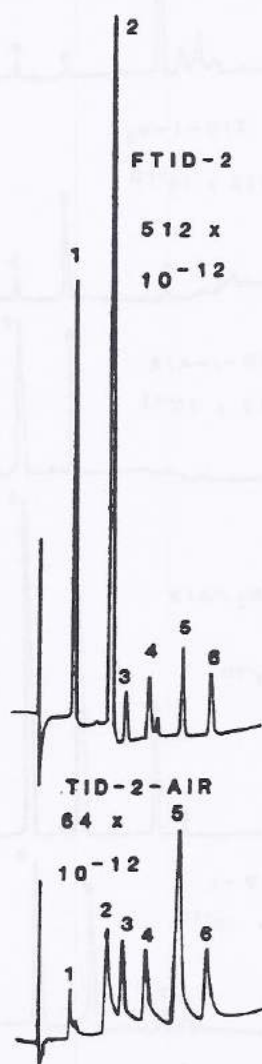

Figure 13. Chromatograms illustrating detector responses obtained before (TID-2-air) and after (FTID-2) combustion of polychlorinated biphenyl compounds. PCB peak identifications: 1=1000 ng 2-chloro-, 2=1000 ng 3,3'-dichloro-, 3=100 ng 2,4,5-trichloro-, 4=100 ng 2,2',4,4'-tetrachloro-, 5=100 ng 2,3',4,5',6-pentachloro-, 6=100 ng 2,2',3,3',6,6'-hexachlorobiphenyl. Column: SP-2250, 200° to 270°C at 10°/min.

be easily converted to the TID-1-air mode by simply turning off the H₂ fuel to the FTID flame. Figure 14 shows that the FTID-1 mode produces a much more uniform response for all the chloro- and nitrophenols of this sample, but the absolute magnitudes of FTID response for the dinitrophenols, pentachlorophenol, and 4-nitrophenol are substantially lower than the TID-1-air response to these compounds.

Figure 15 illustrates the use of the TID-1-air mode to detect EDB in food products. A simple headspace technique was used for the data. One of the advantages of the TID-1-air mode is that it is insensitive to the large air component in the injection headspace vapors. Hence, all chromatographic peaks that are obtained may be attributed to vapors emanating from the food product itself. In addition to EDB, this cake mix sample provided other large TID-1-air signals, thereby suggesting the presence of other halogenated or electronegative constituents that may be of interest in such products. With a better optimization of GC column for the EDB separation, this simple technique should be capable of EDB detection in the 1 to 10 ppb range of concentration in the food product.

Figure 16 illustrates that one difference between a CFID and an FID is that the CFID will provide significant responses to halogenated compounds. Figure 17 further shows that the CFID

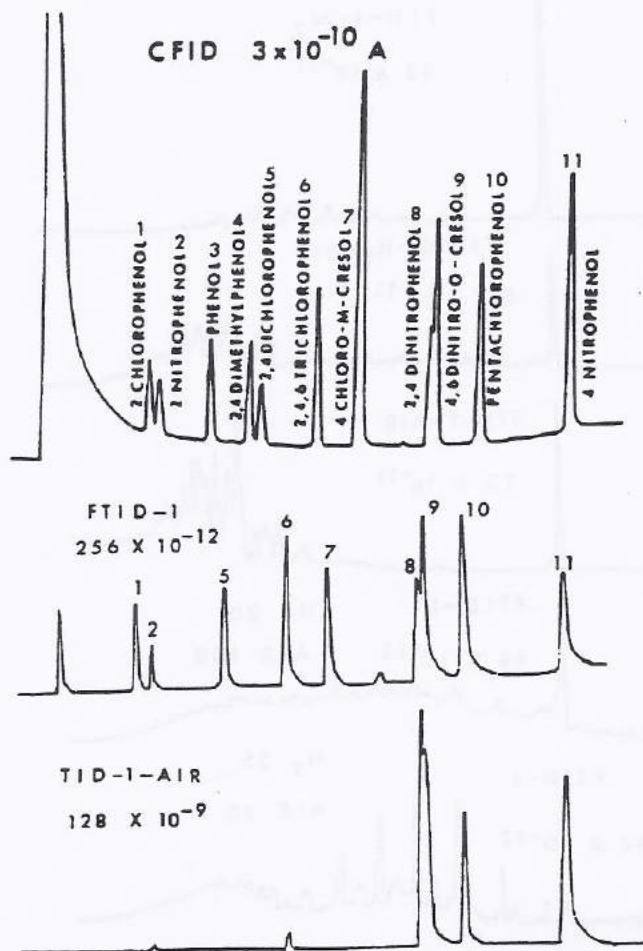

Figure 14. Chromatograms illustrating detector responses obtained before (TID-1-air) and after (FTID-1) combustion of phenol compounds. Sample, column, and program were the same as in Figure 8.

response to halogenated compounds can be selectively enhanced by increasing the source heating current, while the CFID responses to hydrocarbons remain unchanged. Consequently, by judiciously adjusting the source heating current, the CFID response to halogenated and some other heteroatom compounds can be tuned to yield about the same response factor as obtained for hydrocarbons.

Summary

The preceding data have demonstrated that thermionic ionization techniques and equipment have applications in gas chromatography that go well beyond the usual NP detection, such as that of TID-2-H₂/air. To achieve the best possible signal-to-noise ratio and specificity for each mode of detection, the specific chemical composition of the thermionic emission source needs to be matched with the temperature and gas phase environment in which the source is operated.

From their extensive use in NP detection, thermionic ionization detectors are known to often exhibit decreasing sensitivity with increasing operating time as a result of depletion of the thermionic source activity. Consequently, the thermionic source usually needs to be replaced at periodic intervals. Of the different modes of detection described in this report, the NP mode is the most demanding with regard to the operating life of the thermionic source. Generally, in modes of detection (e.g., TID-1-N₂) where the operating temperature is lower and the gas environment is less reactive, the thermionic sources maintain their responses over longer periods of time. For all modes of detection, a practical guideline for achieving the longest possible source lifetime is to operate the thermionic source just hot enough to achieve the response required.

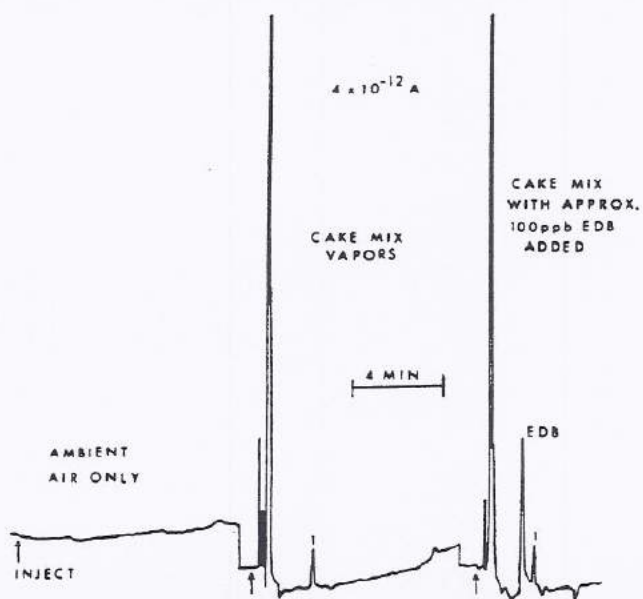

Figure 15. Example of TID-1-air application to determine EDB in cake mix. Sample: headspace vapors from 0.7 gm Duncan Hines Deluxe Yellow Cake Mix in a sealed 2-ml vial. Sampling procedure: heat sealed sample vial to 120°C; extract 200 µl headspace vapor with gas-tight syringe; inject into GC and start column oven temperature program. Column: SP-2100, 40° to 110°C at 10°/min.

The developments of thermionic techniques in GC have also spawned applications of the technology in liquid chromatography detection (17), thin layer chromatography (18), and mass spectrometry ion sources (19). Since there remain to be studied many different combinations of thermionic source compositions, thermionic source temperatures, and gas environment compositions, it is probable that the technology will continue to evolve in coming years.

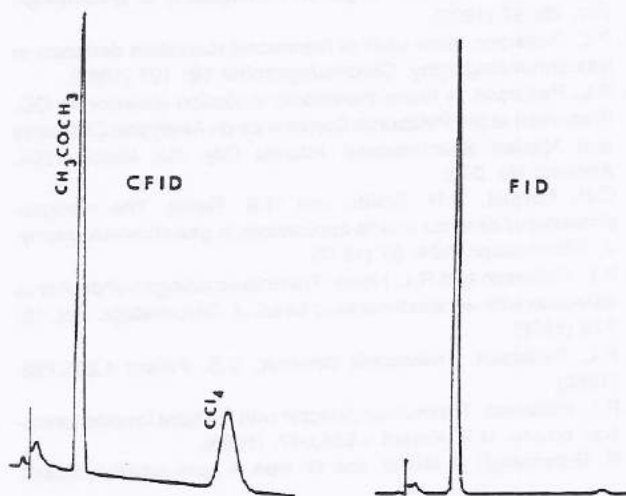

Figure 16. Comparison of CFID and FID responses to a water sample containing acetone and carbon tetrachloride. Column: Chromosorb 102, isothermal 120°C.

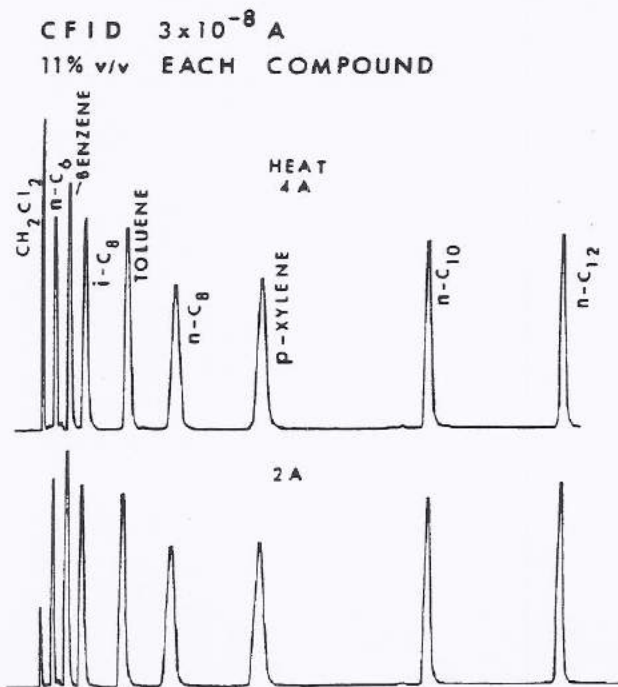

Figure 17. Comparison of CFID responses to sample of methylene chloride and various hydrocarbons at two different magnitudes of heating current to the catalytic source. Column: SP-2100, 40° to 180°C at 10°/min.

References

1. B. Kolb and J. Bischoff. A new design of a thermionic nitrogen and phosphorus detector for GC. *J. Chromatogr. Sci.* 12: 625 (1974).
2. P.L. Patterson. Selective responses of a flameless thermionic detector. *J. Chromatogr.* 167: 381 (1978).
3. B. Kolb, M. Auer, and P. Pospisil. Reaction mechanism in an ionization detector with tunable selectivity for carbon, nitrogen and phosphorus. *J. Chromatogr. Sci.* 15: 53 (1977).
4. P.L. Patterson, R.A. Gatten, and C. Ontiveras. An improved thermionic ionization detector for gas chromatography. *J. Chromatogr. Sci.* 20: 97 (1982).
5. P.L. Patterson. New uses of thermionic ionization detectors in gas chromatography. *Chromatographia* 16: 107 (1982).
6. P.L. Patterson. A flame thermionic ionization detector for GC. Presented at the Pittsburgh Conference on Analytical Chemistry and Applied Spectroscopy, Atlantic City, NJ, March 1984, Abstract No. 372.
7. C.H. Burgett, D.H. Smith, and H.B. Bente. The nitrogen-phosphorus detector and its applications in gas chromatography. *J. Chromatogr.* 134: 57 (1977).
8. P.L. Patterson and R.L. Howe. Thermionic nitrogen-phosphorus detection with an alkali-ceramic bead. *J. Chromatogr. Sci.* 16: 275 (1978).
9. P.L. Patterson. Thermionic detector. U.S. Patent 4,203,726. (1980).
10. P.L. Patterson. Thermionic detector with multiple layered ionization source. U.S. Patent 4,524,047. (1985).
11. R. Greenhaigh, J. Müller, and W. Aue. A pure rubidium/quartz source for alkali flame ionization detectors. *J. Chromatogr. Sci.* 16: 8 (1978).
12. T. Fujii and H. Arimoto. Thermionic ionization detector with lanthanum hexaboride/silicon dioxide thermionic emitter material for gas chromatography. *Anal. Chem.* 57: 490 (1985).
13. C.M. White, A. Robbat, Jr., and R.M. Hoes. Evaluation of a thermionic ionization detector for nitrated polycyclic aromatic hydrocarbons. *Anal. Chem.* 56: 232 (1984).
14. P.L. Patterson. New modes of response for thermionic detectors in GC. Presented at the Pittsburgh Conference on Analytical Chemistry and Applied Spectroscopy, Atlantic City, NJ, March 1983, Abstract No. 423.
15. Y.K. Chau, P.T.S. Wong, G.A. Bengert, and J.L. Dunn. Determination of dialkyllead, trialkyllead, tetraalkyllead and lead (II) compounds in sediment and biological samples. *Anal. Chem.* 56: 271 (1984).
16. M.D. DuPuis and H.H. Hill, Jr. Analysis of gasoline for antiknock agents with a hydrogen atmosphere flame ionization detector. *Anal. Chem.* 51: 292 (1979).
17. V.I. McGuffin and M. Novotny. Thermionic detection in microcolumn liquid chromatography. *Anal. Chem.* 55: 2296 (1983).
18. P.L. Patterson. A specific detector for nitrogen and halogen compounds in TLC on coated quartz rods. *Lipids* 20: 503 (1985).
19. D. Bombick, J.D. Pinkston, and J. Allison. Potassium ion chemical ionization and other uses of an alkali thermionic emitter in mass spectrometry. *Anal. Chem.* 56: 396 (1984).

Manuscript received October 2, 1985;
revision received November 18, 1985.

DETECTORS

Photo Ionization Detector - PID

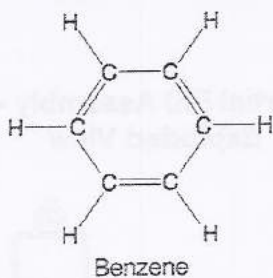

Overview

The Photo Ionization Detector (PID) responds to all molecules whose ionization potential is below 10.6eV, including aromatics and molecules with carbon double bonds. The PID is nondestructive, so the sample can be routed through the PID and on to other detectors. It is often used in series with the FID and / or DELCD. PID detection limits for aromatics are in the ppb range; purge and trap concentration of the sample can lower detection limits to the ppt range. Because of its selective sensitivity, use of the PID is mandated in several EPA methods. The PID detector consists of a 10.6 electron volt (eV) UV lamp mounted on a thermostatted, low-volume (100 μ L), flow-through cell. The temperature is adjustable from ambient to 250°C. Three detector gain levels (LOW, MEDIUM and HIGH) are provided for a wide range of sample concentrations. The PID lamp is held in place by a spring-loaded plate, so that the lamp may be quickly removed for cleaning and replaced without any special tools. The PID can run on air carrier for gasless operation, or for stream monitoring applications where the entire stream of sample is directed through the detector (no column is used).

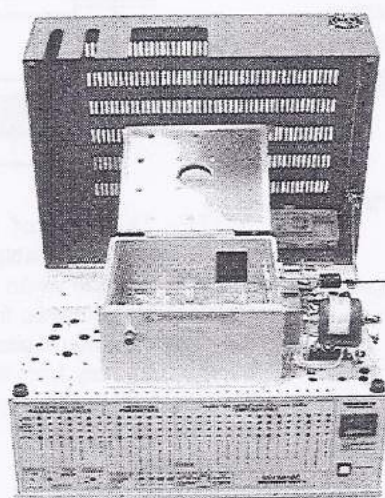

PID in series with a DELCD and an FID on an SRI 8610C chassis

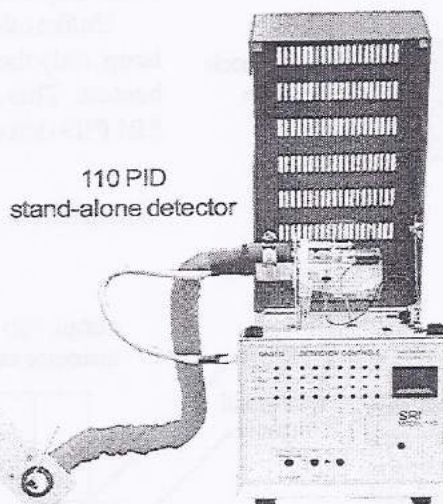

110 PID stand-alone detector

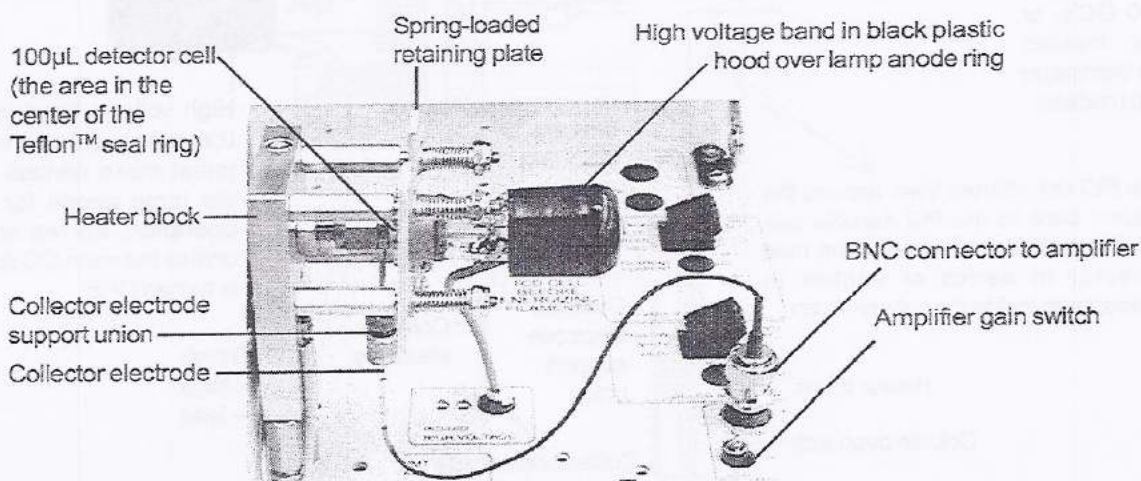

DETECTORS

Photo Ionization Detector - PID

Theory of Operation

10.6eV PID Lamp
(SRI Part # 8670-1242)

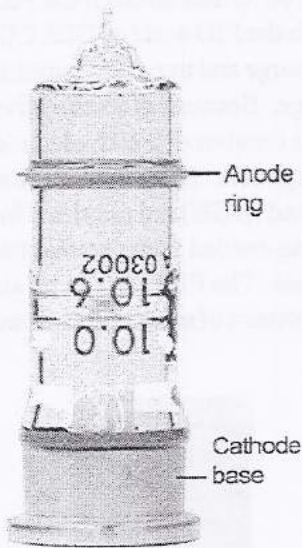

The SRI PID design uses a 10.6eV lamp with a high voltage power supply. Sample laden carrier gas flows from the analytical column into the PID sample inlet, where it is streamed through a 100 μ L flow-through cell. When sample molecules flow into the cell, they are bombarded by the UV light beam. Molecules with an ionization potential lower than 10.6eV release an ion when struck by the ultraviolet photons. These ions are attracted to a collector electrode, then sent to the amplifier to produce an analog signal, which is acquired by the PeakSimple data system.

Unlike other PID designs that heat the entire lamp, only the lamp window of the SRI PID is heated. This results in a longer lamp life for SRI PID detectors.

Partial PID Assembly -
Exploded View

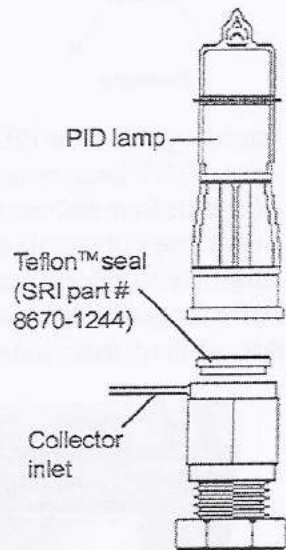

Simplified PID Operational Diagram

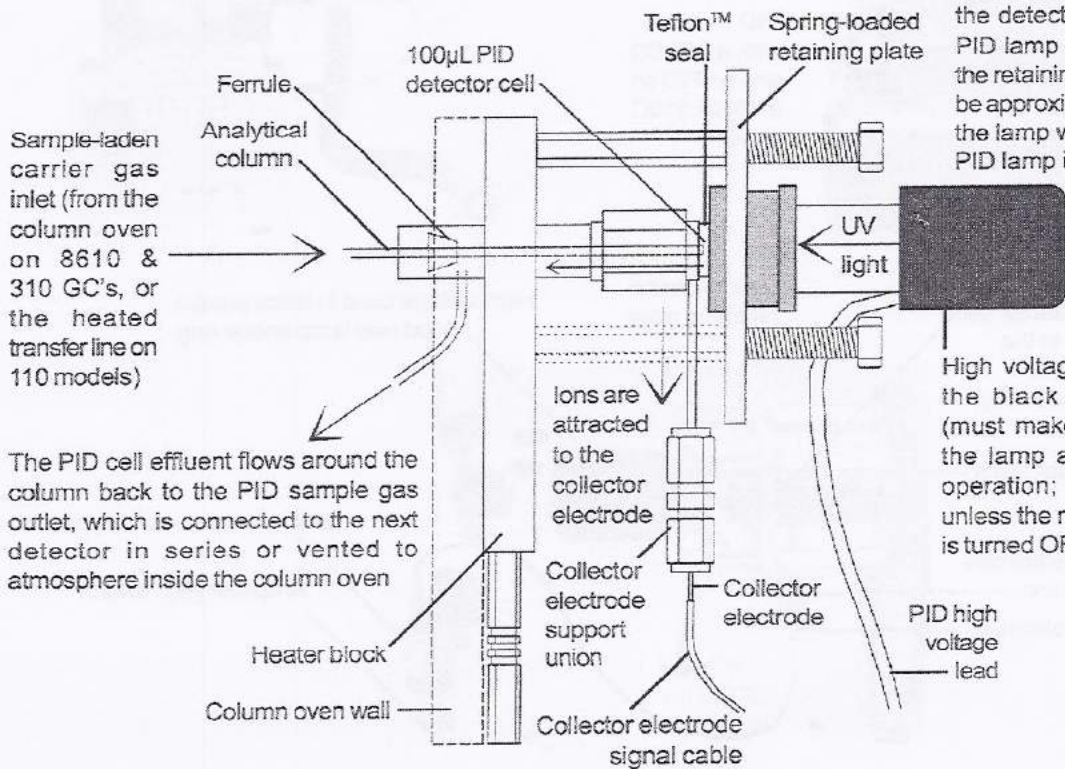

NOTE: The end of the column must be visible in the detector cell when the PID lamp is removed from the retaining plate. It should be approximately 1mm from the lamp window when the PID lamp is in place.

DETECTORS

Photo Ionization Detector - PID

Expected Performance

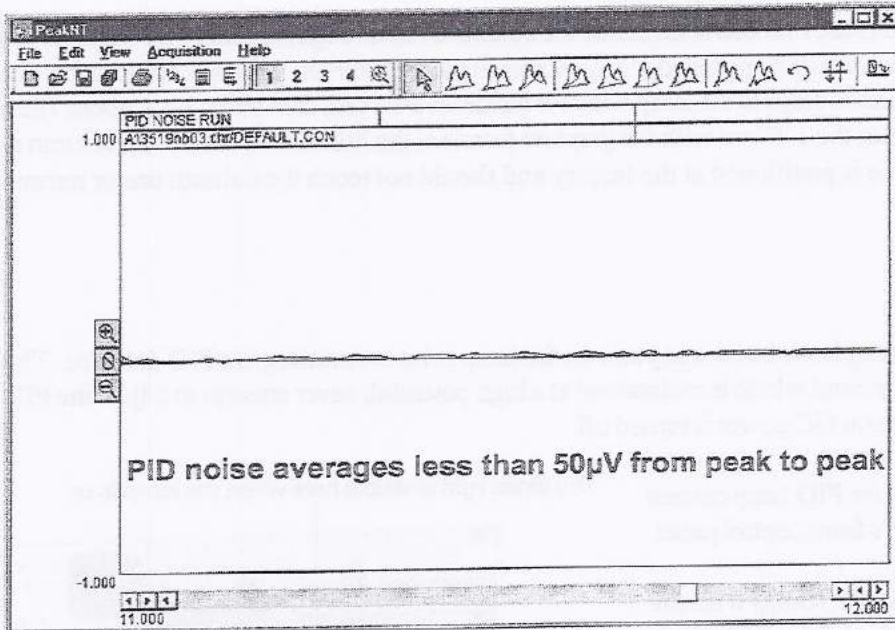

PID Noise Run

Column: 15m MXT-VOL
 Carrier: Helium @ 10mL/min
 PID gain: LOW
 PID temp: 150°C
 PID current: 70

PID BTEX Analysis (in series with FID and DELCD)

Sample: 1µL 100ppm
 BTEX plus
 Column: 15m MXT-VOL
 Carrier: Helium @ 10
 mLs/min
 PID gain: LOW
 PID temp: 150°C
 PID current: 70

Temperature program:
 Initial Hold Ramp Final
 40°C 2.00 15.00 240°C
 240°C 10.00 0.00 240°C

Results:

Component	Retention	Area
Benzene	2.418	313.0540
TCE	3.066	231.5120
Toluene	4.600	309.2120
PCE	5.433	218.6230
Ethyl Benzene	6.700	286.0900
Ortho Xylene	7.383	298.9190
Bromoform	7.650	55.9460
Total		1711.3560

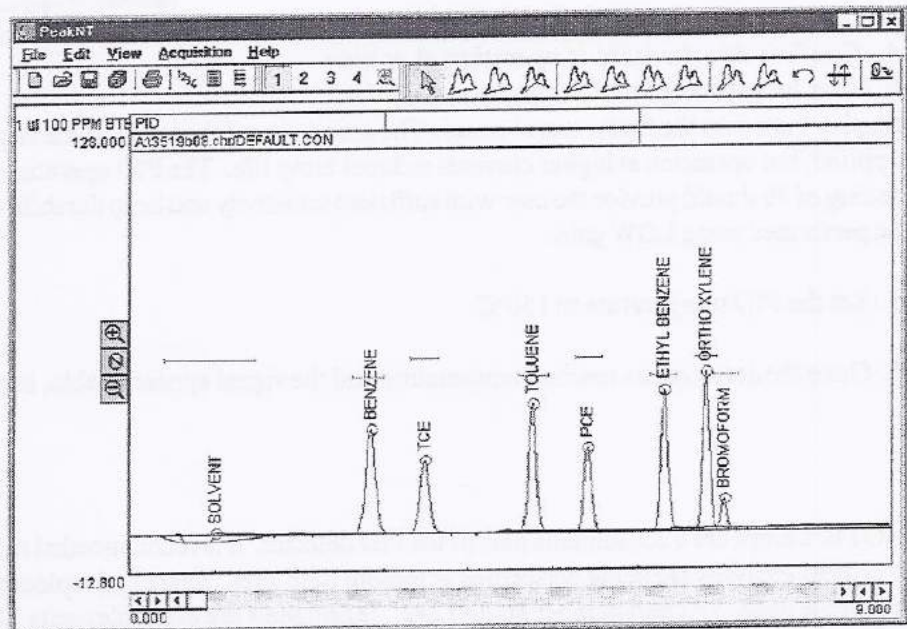

DETECTORS

Photo Ionization Detector - PID

General Operating Procedure

The capillary column enters the PID cell from inside the column oven through the bulkhead fitting in the insulated oven wall. The column may be installed with the lamp in place. Insert the capillary column into the PID detector inlet until the column stops at the lamp window inside the PID cell, then pull it back about 1 mm from the lamp window. Tighten the 1/8" nut with the graphite ferrule at the PID inlet to secure the column in place. The collector electrode is positioned at the factory and should not touch the column under normal circumstances.

1. Always ensure that the black plastic hood is in place on the lamp prior to operating the PID detector. The hood contains the high voltage band which is maintained at a high potential; never attempt to adjust the PID high voltage band unless the main GC power is turned off.

2. Turn ON the GC. Turn ON the PID lamp current with the flip switch on the GC's front control panel.

3. Set the PID current to 70 (= 0.70ma) with the trimpot setpoint on the top edge of the GC's front control panel. Use the flat blade screwdriver provided with your GC to adjust the trimpot. The lamp should emit a violet-colored light visible down the center of the tube

The violet light is visible here when the lamp is on

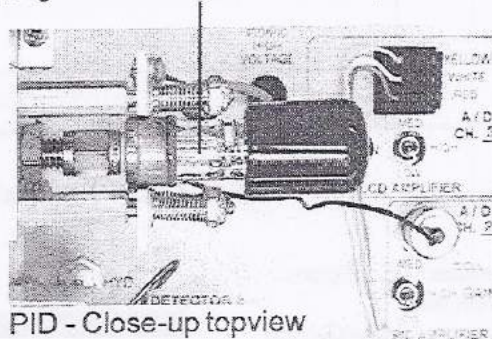

PID - Close-up topview

4. Confirm that the lamp is operating at or near 0.70ma by pressing the PID detector ACTUAL display button on the front control panel. The sensitivity of the lamp increases proportionally to the current applied, but operation at higher currents reduces lamp life. The PID operating current range is 70-125. A setting of 70 should provide the user with sufficient sensitivity and lamp durability. Most PID applications can be performed using LOW gain.

5. Set the PID temperature to 150°C.

6. Once the detector has reached temperature and the signal appears stable, sample may be introduced.

NOTE: Lamps are a consumable part of the PID detector. It is recommended to have a spare lamp available if critical analyses are being performed at remote field sites. Spare and replacement 10.6eV PID lamps are available under SRI part number 8670-1242. Teflon seals are available under SRI part number 8670-1244.

Troubleshooting and Maintenance Cleaning the PID Lamp

Over time, during normal operation, a film of contaminants will condense on the PID lamp window. Typically, this film is a result of stationary phase column bleed. To minimize contaminant condensation and thus lamp window cleaning, avoid heating the column any higher than absolutely necessary. Contaminant condensation can block the photons, reducing lamp emissions and sensitivity. Therefore, the PID lamp window must be cleaned when an appreciable change in sensitivity has been observed by the operator. Because the response change resulting from cleaning the lamp window usually requires detector recalibration, frequent cleaning is not recommended.

The PID lamp window

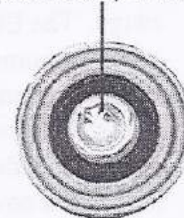

1. Turn the PID current OFF with the switch on the GC's front control panel. Turn the GC OFF and let the PID detector assembly cool enough to touch it without getting burned.

2. Disconnect the high-voltage band from the lamp anode by removing the black plastic hood.

3. Grasp the spring-loaded retainer plate with the fingers of one hand and push or pull it toward the PID lamp; it doesn't take much force to move the plate enough for lamp removal. Slide the PID lamp up and out of the PID detector assembly.

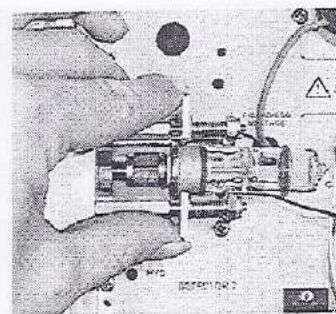

4. Clean the lamp window using a mild abrasive cleanser like Bon Ami or Comet. Wet your finger, and make a paste with a small amount of cleanser. Scrub the lamp window clean in a circular motion with your finger.

5. Rinse the lamp window clean with water. Dry the lamp with a paper towel.

6. Inspect the Teflon™ seal for cuts or nicks. A damaged seal will not affect the PID response, but it may provide a leak site that will reduce the amount of sample delivered to any subsequent detector.

The collector electrode protrudes into the cell

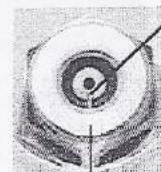

Teflon™ seal

7. With the lamp removed, the collector electrode is visible where it protrudes into the cell. Check the collector electrode for any visible residues, films, discolorations, etc. If present, they may impede the flow of ions from the sample molecules to the collector electrode. To clean the collector electrode, gently use a small file to remove any residues from its tip. Blow the residue off the collector electrode and surrounding areas.

8. Open the spring-loaded retainer plate and replace the PID lamp snug against the seal. The lamp window has a slightly larger diameter than the seal; try to center it against the seal. Replace the high voltage band / black plastic lamp hood.

Make sure the lamp window is centered over the Teflon seal and snug against it

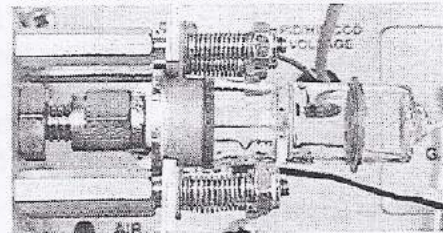

9. Recalibrate the PID detector before returning it to service.

DETECTORS

Electron Capture Detector - ECD

Theory of Operation

The radioactive Nickel 63 sealed inside the ECD detector emits electrons (beta particles) which collide with and ionize the make-up gas molecules (either nitrogen or P5). This reaction forms a stable cloud of free electrons in the ECD detector cell. The ECD electronics work to maintain a constant current equal to the standing current through the electron cloud by applying a periodic pulse to the anode and cathode. The standing current value is selected by the operator; the standing current value sets the pulse rate through the ECD cell. A standing current value of 300 means that the detector electronics will maintain a constant current of 0.3 nanoamperes through the ECD cell by periodically pulsing. If the current drops below the set standing current value, the number of pulses per second increases to maintain the standing current.

ECD Detector Operational Diagram

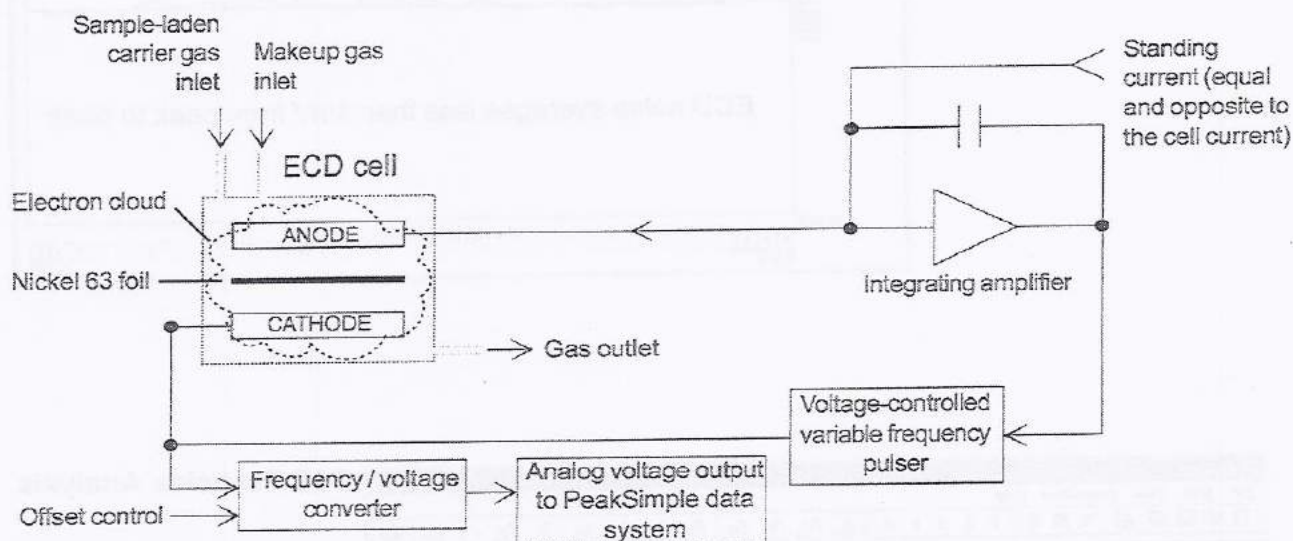

When electronegative compounds enter the ECD cell from the column, they immediately combine with some of the free electrons, temporarily reducing the number remaining in the electron cloud. When the electron population is decreased, the pulse rate is increased to maintain a constant current equal to the standing current. The pulse rate is converted to an analog output, which is acquired by the PeakSimple data system. Unlike other detectors which measure an increase in signal response, the ECD detector electronics measure the pulse rate needed to maintain the standing current.

Example Pulse Trains

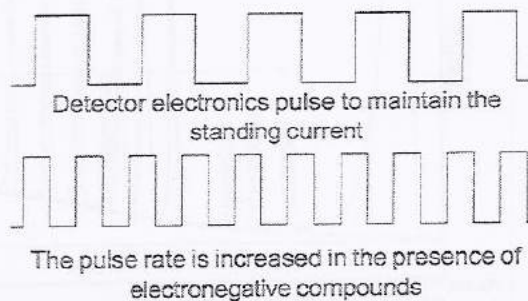

DETECTORS

Electron Capture Detector - ECD

General Operating Procedure

The following suggestions are specific to your SRI ECD-equipped GC. Consult the Valco ECD detector manual for carrier gas purity requirements, carrier gas system configuration, and other general ECD detector information. Keep in mind that the electronics schematics in the Valco manual do not apply to your ECD-equipped SRI GC.

1. Cap off the carrier inlet to the ECD cell (in the column oven).
2. Connect the makeup gas and let it flow through and purge the ECD cell. Makeup flow is 40-100mL; typically 60mL.
3. Heat the ECD detector to 150°C to verify that the baseline noise and offset are normal. 150°C is hot enough to evaporate off water but low enough to avoid oxidation of the nickel foil which can occur at high temperatures in the presence of oxygen. Once you have verified the ECD's operation at this temperature, you may heat it to higher temperatures.
4. Turn on the ECD standing current (the ECD current ON / OFF switch is located on the front control panel of the GC, under "DETECTOR PARAMETERS"). As a rule of thumb, an ECD detector requires enough nitrogen makeup flow (40-100mL/min) to significantly dilute the carrier in order to help keep detector noise down; the ECD can tolerate a 6:1 ratio of nitrogen to helium.

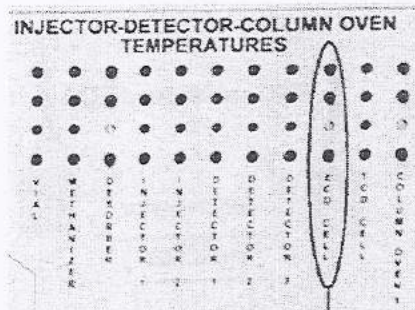

ECD cell temperature display

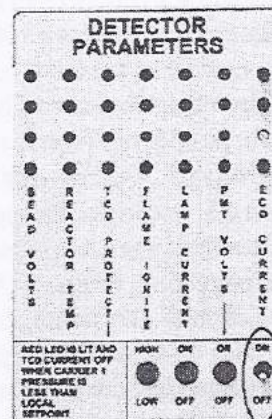

ECD standing current ON/OFF switch

With the carrier and makeup gas connected and flowing, check the offset from zero. The millivolt reading should be between 100 and 500mV. If the signal offset is less than 100mV, the standing current needs to be increased. If the signal offset is higher than 500mV, the standing current needs to be decreased. Once the signal is relatively quiet and stable, set the temperature to whatever is appropriate for your analysis by adjusting the trimpot setpoint with the flat blade screwdriver provided.

5. When the ECD detector cell reaches temperature, let the system stand until you get a stable millivolt reading. Once the system exhibits a stable baseline, reconnect the column. Observe the signal in the presence of the carrier flow. If it is significantly higher, it indicates contamination introduced on the carrier flow. If the millivolt reading is still relatively stable in the presence of carrier flow, then sample may be injected. Avoid samples with high concentrations of electronegative compounds; they may effect ECD operation for some time thereafter, as they could take too long to dissipate.
6. You may need to adjust the ECD standing current using its trimpot setpoint. The trimpot setpoints are located on the top edge of the front control panel, directly above the display push-buttons for each controlled zone. Remember, increasing the standing current increases the ECD's sensitivity and raises the baseline offset.

ECD Troubleshooting

If you are experiencing baseline offset and noise problems with your ECD detector, try the following two diagnostic tests:

1. Verify that the ECD amplifier electronics are working properly by removing the detector from the circuit and inserting a 1000M Ω test resistor in its place. The parts kit in the tackle box included with your GC under the red lid contains a 1000M Ω resistor for this test. Turn the ECD current off. The anode and cathode connections are BNC connectors located on the GC chassis near the base of the ECD detector housing. Disconnect these two BNC connectors from the detector electronics, and install the 1000M Ω test resistor as a jumper between the center conductor in the anode BNC jack and the center conductor in the cathode BNC jack. Zero the data system signal. Turn the ECD current back on, and check the signal offset (observe the mV reading in the upper right area of the PeakSimple chromatogram window. With the test resistor in the detector's place, the signal offset should be 120-150mV with the standing current at 300. If the signal offset is pegged up or down (5000mV or 1500mV, respectively), there is a problem with your ECD detector electronics. Try turning off the GC power for at least 30 seconds, with the test resistor still in place, then turning it back on to see if the signal offset still indicates a problem. If the signal offset is at zero with the test resistor in place, check to make sure that you are looking at the correct detector channel. If you are observing a signal offset of zero in the ECD detector channel, call technical support.

The ECD anode and cathode are connected to the ECD amplifier via BNC cables

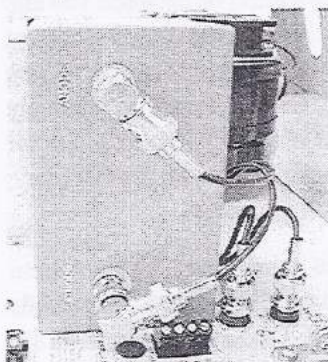

Anode and cathode BNC connectors

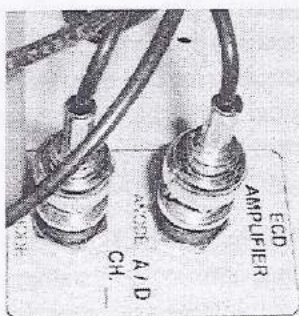

ECD electronics test

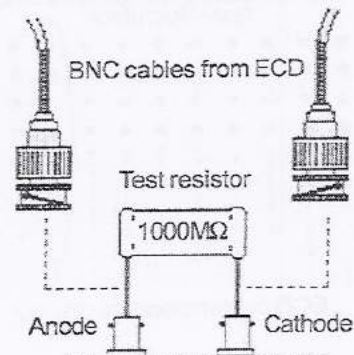

2. Operate the ECD on make-up gas only by disconnecting the column from the ECD. With the standing current still set at 300, observe the signal offset and noise. If it drops, then the problem is being introduced into the GC and ECD by the carrier gas through the column.

Tip: In most situations, the ECD will be used to detect sample components that are reactive with metal. Use glass, fused silica, or fused silica lined metal capillary columns to help avoid reactive sites and ghost peaks.

DETECTORS

Dry Electrolytic Conductivity Detector - DELCD

Overview

The Dry Electrolytic Conductivity detector, or DELCD, is selective to chlorinated and brominated molecules. It differs from the traditional wet ELCD in that it does not use a solvent electrolyte, and the reaction products are detected in the gaseous phase. The SRI DELCD is available alone or in combination with the FID detector. On its own, the detection limits of the DELCD are in the low ppb range. In combination with the FID, its detection limits are in the low ppm range. The FID/DELCD combination enables the operator to reliably identify hydrocarbon peaks detected by the FID as halogenated or not. Because the DELCD operates at 1000°C, it can tolerate the water-saturated FID effluent, measuring the chlorine and bromine content simultaneously with the FID measurement of the hydrocarbon content. All hydrocarbons are converted by the FID flame to CO₂ and H₂O prior to reaching the DELCD, thus preventing contamination of the DELCD by large hydrocarbon peaks.

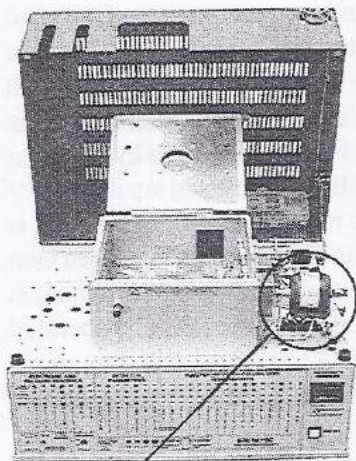

DELCD on an 8610C GC

DELCD - À la carte

Close-up of the same DELCD detector

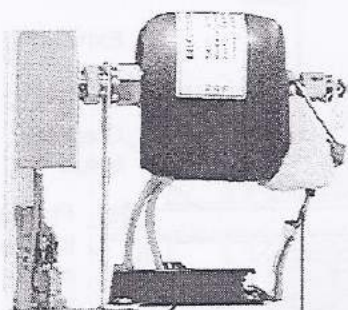

DELCD heater terminal
DELCD collector & thermocouple leads

FID / DELCD Combo Detector

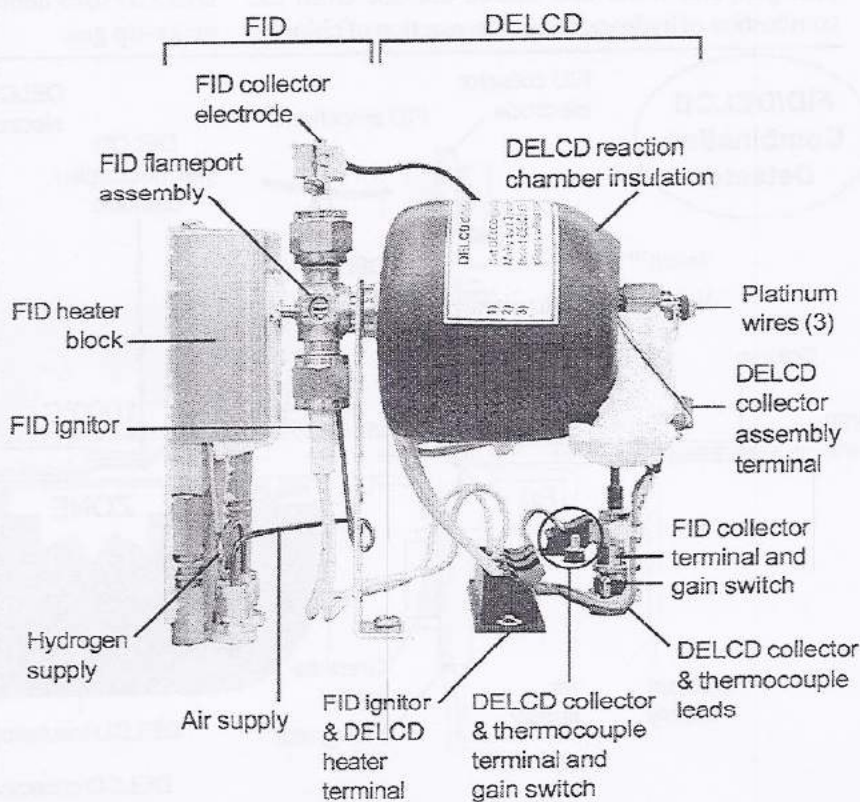

DETECTORS

Dry Electrolytic Conductivity Detector - DELCD

Theory of Operation

The DELCD consists of a small ceramic tube—the DELCD reactor—heated to 1000°C. Inside the reactor, a platinum thermocouple measures the detector temperature, and a nichrome collector electrode measures the conductivity of the gases flowing through the DELCD. The detector response is dependent upon its temperature. Therefore, the control circuit must maintain the temperature, within a fraction of a degree, at 1000°C.

When combined with the FID detector, the DELCD is mounted on the FID exhaust. Column effluent enters the FID flame where hydrocarbons are ionized and combusted. Electrons freed in the ionization process are collected by the FID collector electrode, which has an internal diameter of 1mm (0.040"). Due to its small I.D., the collector electrode acts as a restrictor, splitting the FID exhaust gases so that it takes about half of the flow, and the remainder is directed to the DELCD. The FID exhaust gases consist of un-combusted hydrogen and oxygen, nitrogen, and water and carbon dioxide from the combustion of hydrocarbons. The reaction of chlorine

or bromine and hydrogen forms HCl and HBr, and the reaction of chlorine or bromine and oxygen forms ClO_2 and BrO_2 . The DELCD detects the oxidized species of chlorine and bromine, such as ClO_2 and BrO_2 . It does not detect the acids HCl or HBr like the conventional wet ELCD. In the hydrogen rich effluent from the FID flame, the chlorine and bromine preferentially react with hydrogen (or the hydrogen in water) to make HCl-HBr. Given equal availability of hydrogen and oxygen molecules, a chlorine atom is 100 times more likely to react with the hydrogen than the oxygen. Therefore, the FID/DELCD combination is 100 times less sensitive than the DELCD operated with the FID off. The SRI FID/DELCD is operable as a combination detector, as an FID only, or as a DELCD only.

A DELCD only detector receives the sample laden carrier gas directly from the column or from a non-destructive detector outlet, like the PID. It is mounted on the heater block on the column oven wall so that the column effluent is maintained at a temperature consistent with the analysis. This type of high sensitivity DELCD uses helium or nitrogen carrier gas and air make-up gas.

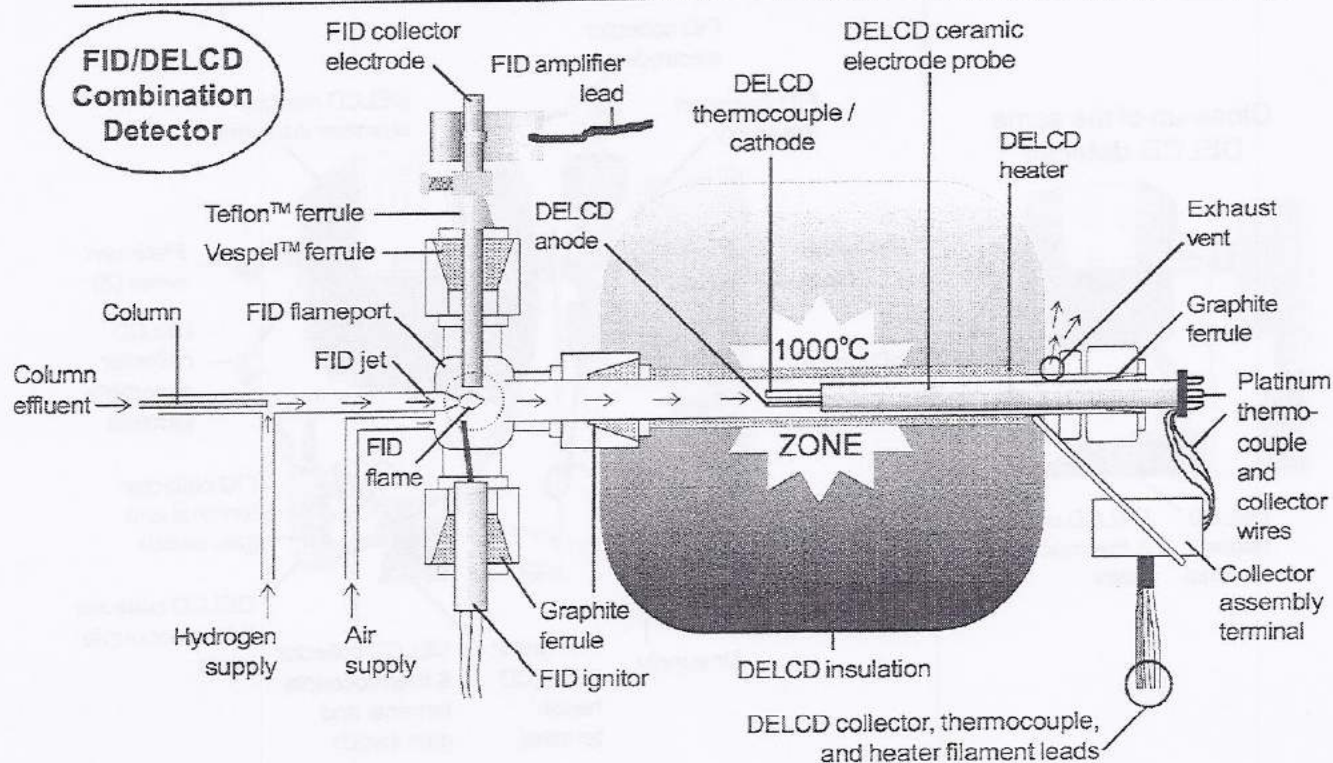

DETECTORS

Dry Electrolytic Conductivity Detector - DELCD

Expected Performance

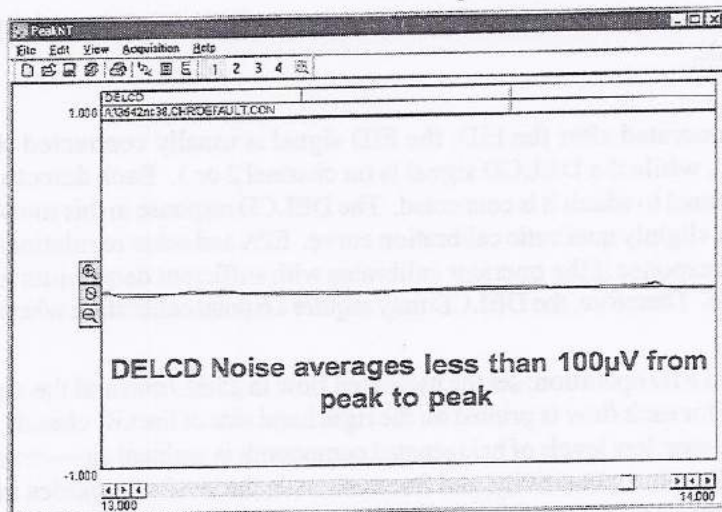

DELCD Noise Run

Column: 15m MXT-VOL
 Carrier: helium @ 10mL/min
 DELCD gain: LOW
 DELCD heater block temp: 150°C
 DELCD reactor setpoint: 260

Temperature program:

Initial	Hold	Ramp	Final
80°C	20.00	0.00	80°C

FID / DELCD Combo Test Run

Sample: 1µL 100ppm BTEX Plus
 Column: 15m MXT-VOL
 Carrier: helium @ 10mL/min

Temperature program:

Initial	Hold	Ramp	Final
40°C	2.00	15.00	240°C

DELCD gain: LOW

DELCD heater block temp: 150°C

DELCD reactor setpoint: 260

DELCD Results:

Component	Retention	Area
TCE	3.483	463.5080
PCE	5.416	532.2900
Bromoform	7.016	759.6650
Total		1755.4630

FID gain: HIGH

FID temp: 150°C

FID ignitor: -400

FID Results:

Component	Retention	Area
Solvent	0.600	144406.8420
Benzene	2.850	1074.0740
TCE	3.500	378.3505
Toluene	4.766	1109.8590
PCE	5.416	364.5700
Ethyl Benzene	6.316	1103.6370
Ortho Xylene	6.800	1135.6855
Bromoform	7.016	220.3325
Total		149793.3505

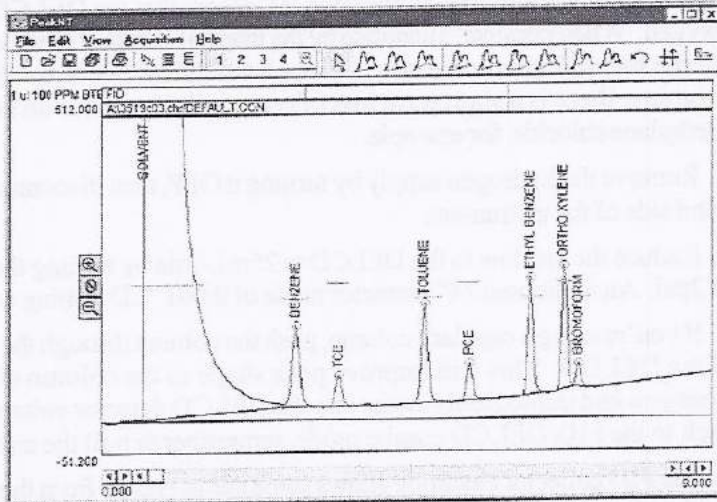
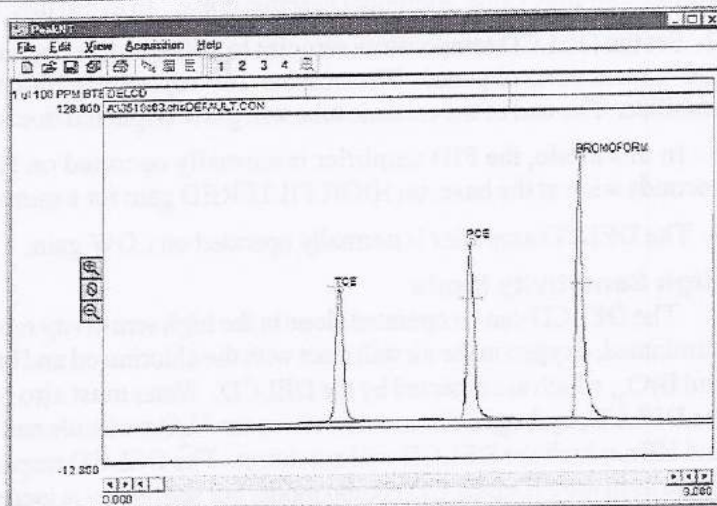

DETECTORS

Dry Electrolytic Conductivity Detector - DELCD

General Operating Procedure

The FID/DELCD combination detector can be operated in the Combo Mode, the High Sensitivity Mode (DELCD only), or the FID only mode.

Combo Mode

In the Combo Mode, the DELCD is operated after the FID; the FID signal is usually connected to Channel 1 on the PeakSimple data system, while the DELCD signal is on channel 2 or 3. Each detector amplifier is factory labeled with the data channel to which it is connected. The DELCD response in this mode is useable from 1 to 1000 nanograms with a slightly quadratic calibration curve. EPA and other regulations allow the use of detectors with non-linear response if the operator calibrates with sufficient data points to accurately model the detector response curve. Therefore, the DELCD may require a 6 point calibration where 5 point calibration is normally required.

1. Set the hydrogen and air flows for normal FID operation: set the hydrogen flow to 25mL/min and the air flow to 250mL/min. The pressure required for each flow is printed on the right hand side of the GC chassis. (NOTE: If you're using a built-in air compressor, low levels of halogenated compounds in ambient air—even levels below 1ppm—can cause the DELCD to lose sensitivity, and fluctuations in the level of organics in ambient air may cause additional baseline noise. To avoid this, use clean, dry tank air.)
2. Set the DELCD temperature setpoint to 260 by adjusting the appropriate trimpot on the top edge of the GC's front control panel. The number 260 represents 1000°C; the DELCD will heat to about 254 and stabilize. The end of the ceramic tube will glow bright red due to the high temperature.
3. In this mode, the FID amplifier is normally operated on HIGH gain or, if the peaks are more than 20 seconds wide at the base, on HIGH FILTERED gain for a more quiet baseline.
4. The DELCD amplifier is normally operated on LOW gain.

High Sensitivity Mode

The DELCD can be operated alone in the high sensitivity mode by eliminating hydrogen. With hydrogen eliminated, oxygen in the air will react with the chlorinated and brominated molecules at 1000°C to form ClO_2 and BrO_2 , which are detected by the DELCD. Water must also be eliminated; at the high temperatures inside the DELCD, hydrogen disassociates from the H_2O molecule and becomes available as a reactant to form HCl and HBr, which the DELCD will not detect. The DELCD response curve is quadratic in the high sensitivity mode as in the FID/DELCD combo mode, but sensitivity is increased by 100 to 1000 times. In this mode, the DELCD can perform much like an ECD, except that the DELCD is more selective for halogens and blind to oxygen. When possible, quantitate by the internal standard method, using a chlorinated/brominated compound for the internal standard peak. Although the DELCD will not be damaged by large quantities of chlorine/bromine, there is a short term loss of sensitivity for about an hour following the injection of 1 μL of pure methylene chloride, for example.

1. Remove the hydrogen supply by turning it OFF, then disconnecting it at the GC's inlet bulkhead on the left hand side of the instrument.
2. Reduce the air flow to the DELCD to 25mL/min by turning the the air pressure trimpot setpoint down to 1 or 2psi. An additional 24" restrictor made of 0.001" I.D. tubing would be useful for fine pressure adjustment.
3. If you're using a capillary column, push the column through the FID jet until it just enters the ceramic tubing of the DELCD. This will improve peak shape as the column effluent will be discharged into the flowing airstream and immediately swept into the DELCD detector volume by the air make-up gas. (When switching back to the FID/DELCD combo mode, remember to pull the column back into the FID jet.)
4. The FID collector electrode allows some gas to escape from the FID combustion area, which is undesirable for the high sensitivity mode. Remove the FID collector electrode and replace it with a 1/4" cap fitting.

DETECTORS

Dry Electrolytic Conductivity Detector - DELCD

General Operating Procedure continued

FID/DELCD - FID Only

1. Remove the DELCD heater wires from the push terminals. Remove the three DELCD collector and thermocouple wires (yellow, white and red) from the screw terminals.
2. Disconnect the DELCD detector assembly from the FID exhaust by using a wrench to loosen the 1/4" Swagelok fitting securing the two detector parts together.
3. Use a cap nut to seal the DELCD connection on the FID flameport.
4. Set the FID amplifier gain switch to HIGH for most hydrocarbon applications. If peaks of interest go off the scale (greater than 5000mV), set the gain to MEDIUM. When peaks of interest are 20 seconds wide or more at the base and extra noise immunity is desired, set the gain switch to HIGH (filtered). This setting broadens the peaks slightly.
5. Set the FID hydrogen flow to 25mL/min, and the FID air supply flow to 250mL/min. The approximate pressures required are printed in the gas flow chart on the right-hand side of the GC.
6. Ignite the FID by holding up the ignitor switch for a couple of seconds until you hear a small POP. The ignitor switch is located on the front panel of your SRI GC under the "DETECTOR PARAMETERS" heading (it is labelled vertically: "FLAME IGNITE").
7. Verify that the FID flame is lit by holding the shiny side of a chromed wrench directly in front of the collector outlet. If condensation becomes visible on the wrench surface, the flame is lit.

DELCD Only

1. Set the helium carrier gas flow to 10mL/min and the air make-up flow to 25mL/min. Clean, dry tank air helps to obtain the best achievable DELCD sensitivity and signal stability.
2. Set the DELCD reactor temperature setpoint to 260 (= 1000°C) by adjusting the trimpot on the top edge of the GC's front control panel. The DELCD will heat to about 254 and stabilize. The ceramic tube will glow bright red from the heat.
3. By adjusting the appropriate trimpot, set the thermostatted DELCD heater block temperature to 25°C higher than the "Final" temperature you have entered in the temperature program.
4. The DELCD amplifier is normally operated on LOW or MEDIUM gain.

DETECTORS

Dry Electrolytic Conductivity Detector - DELCD

Troubleshooting and Maintenance

Installing the Spare DELCD Cell

Each SRI DELCD detector is shipped with a spare DELCD cell. Because the DELCD heater operates close to 1000°C, it will burn out and fail eventually. Follow the instructions below to remove the old cell and install the new one.

1. With the GC power OFF, remove the DELCD heater wires (2) from the push terminals and the DELCD thermocouple and collector wires (3) from the screw terminals.
2. Remove the DELCD cell by using a wrench to loosen the 1/4" fitting that secures it on the FID exhaust port or on the heater block. You may have to hold the insulation aside to freely access the fitting; it is soft and may be compressed by hand.
3. Position the new cell on the fitting with the label facing up, as the DELCDs are shown on the **Overview** page. Be sure to push the DELCD cell all the way into the FID.
4. Secure the new DELCD cell into place by tightening with a wrench the fitting that holds it onto the FID exhaust or the heater block.
5. Carefully lower the red lid to make sure that it does not touch the DELCD cell; the cell will crack if the lid hits it. There should be at least 0.5" of clearance between the red lid and the edge of the DELCD cell.
6. Sensitivity may improve for the first 24 hours of operating time with the new cell installed.